

PANNELLI E COLONNE DOCCIA

SHOWER PANELS AND COLUMNS

FINITURE SPECIALI SU RICHIESTA:
SPECIAL FINISHING ON REQUEST:

-  **OR** Oro | Gold
-  **VO** Vecchio Ottone | Old Brass
-  **VR** Vecchio Rame | Old Copper
-  **NS** Nickel Spazzolato | Satin Nickel
-  **NE** Nero | Black
-  **BI** Bianco | White

Sugli articoli in finitura speciale si potrebbero presentare delle imperfezioni, dovute al tipo di lavorazione.
Please kindly note that on items in special finishing you may have imperfections due to the type of machining.









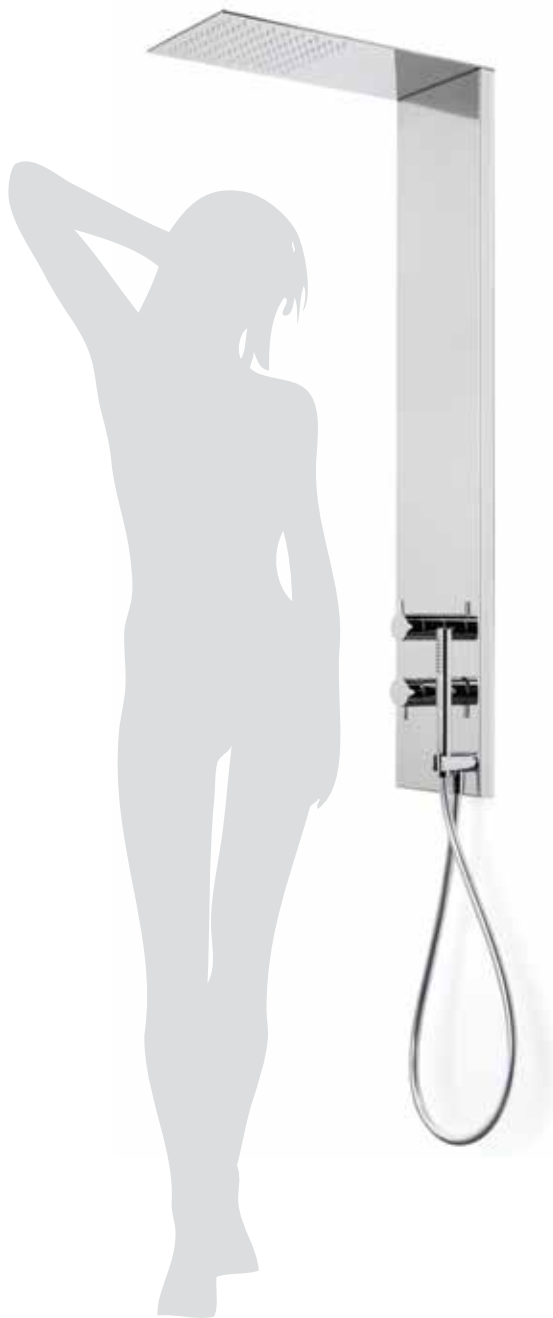
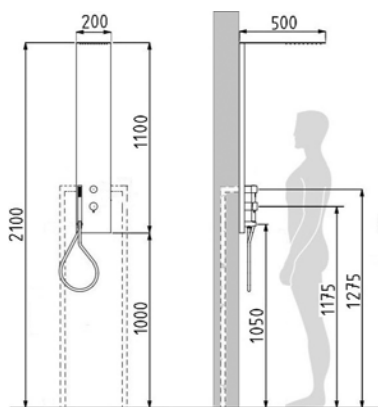

MIRROR S



-  **CR** Cromo | Chrome
-  **OR** Oro | Gold
-  **NS** Nickel Spazzolato | Satin Nickel
-  **NE** Nero | Black
-  **BI** Bianco | White

S80041ACCM con monocomando | with shower mixer

S80041ACCT con termostatico | with thermostatic





Pannello doccia esterno in acciaio INOX lucido "super mirror", 2 uscite, completo di termostatico.

External shower panel made with super mirror stainless steel, 2 outputs and thermostatic mixer.

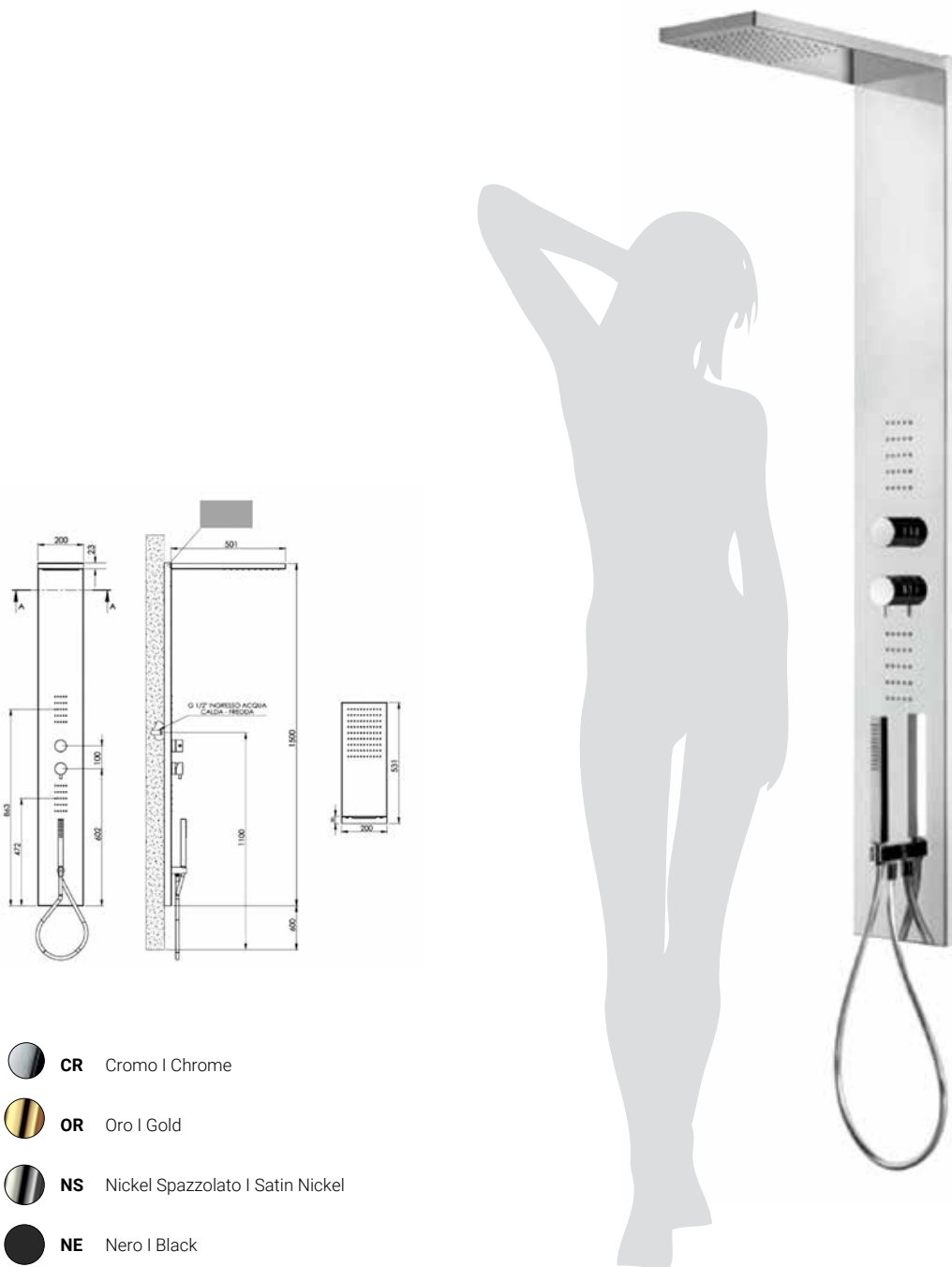

MIRROR M



-  **CR** Cromo | Chrome
-  **OR** Oro | Gold
-  **NS** Nickel Spazzolato | Satin Nickel
-  **NE** Nero | Black
-  **BI** Bianco | White

M80041ACCM con monocomando | with shower mixer

M80041ACCT con termostatico | with thermostatic





Pannello doccia esterno in acciaio INOX lucido "super mirror", 3 uscite, completo di termostatico.

External shower panel made with super mirror stainless steel, 3 outputs and thermostatic mixer.

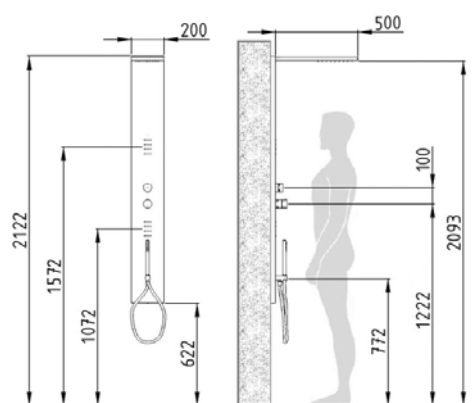

MIRROR L



-  **CR** Cromo | Chrome
-  **OR** Oro | Gold
-  **NS** Nickel Spazzolato | Satin Nickel
-  **NE** Nero | Black
-  **BI** Bianco | White

L80041ACCM con monocomando | with shower mixer

L80041ACCT con termostatico | with thermostatic

Pannello doccia esterno in acciaio INOX lucido "super mirror", 4 uscite, completo di termostatico.

External shower panel made with super mirror stainless steel, 4 outputs and thermostatic mixer.





colonna TOPAZIO con soffione NETTUNO - finitura oro

Le composizioni delle colonne docce sono PERSONALIZZABILI variando soffione e doccetta.

The customer is free to chose how to PERSONALYZE each shower's colums by changing headshower and shower hand.

COD.	SEZ.		PAG.
40	○	ANDROMEDA	32
30	□	TOPAZIO	34
32	○	GIADA	38
35	○	GEMMA	42
31	○	AMBRA	46
34	○	PERLA	50
38	□	SMERALDO Q	54
38	○	SMERALDO T	58
36	○	ZAFFIRO T	62
36	□	ZAFFIRO Q	66
37	○	TURCHESE	70
Linea ECO _ ECO line			
76	○	MARE E MONTI	76
77	○	SNELLA T - SNELLA Q	80
C035	○	ICE	86

<p>Caratteristiche:</p> <ul style="list-style-type: none"> - spessore tubo OTTONE 1,5 mm - scorrevole portadoccia in OTTONE <p>Specifics:</p> <ul style="list-style-type: none"> - thickness BRASS tube 1,5 mm - chromed BRASS sliding bar shower holder
<p>Caratteristiche:</p> <ul style="list-style-type: none"> - spessore tubo OTTONE 1 mm - scorrevole portadoccia in ABS <p>Specifics:</p> <ul style="list-style-type: none"> - thickness BRASS tube 1,5 mm - chromed ABS sliding bar shower holder

Accessori colonne doccia
Shower columns accessories 90

Rubineria colonne doccia
Shower columns taps 92

Cartucce
Cartridges 93

Come ordinare una colonna doccia
How to order a shower column 94

Esempi combinazioni doccia
Example of combinations 96

Istruzioni di montaggio
Installation instructions 98

FINITURE E MISURE SPECIALI SU RICHIESTA

SPECIAL FINISHING AND MEASURES ON REQUEST

- | | |
|--|--|
|  OR Oro Gold |  NS Nickel Spazzolato Satin Nickel |
|  VO Vecchio Ottone Old Brass |  NE Nero Black |
|  VR Vecchio Rame Old Copper |  BI Bianco White |



colonna **AMBRA** con soffione **MERCURY** - finitura nero

Sugli articoli in finitura speciale si potrebbero presentare delle imperfezioni, dovute al tipo di lavorazione.
Please kindly note that on items in special finishing you may have imperfections due to the type of machining.



colonna **GIADA** con soffione **MERCURY** - finitura cromo

ANDROMEDA

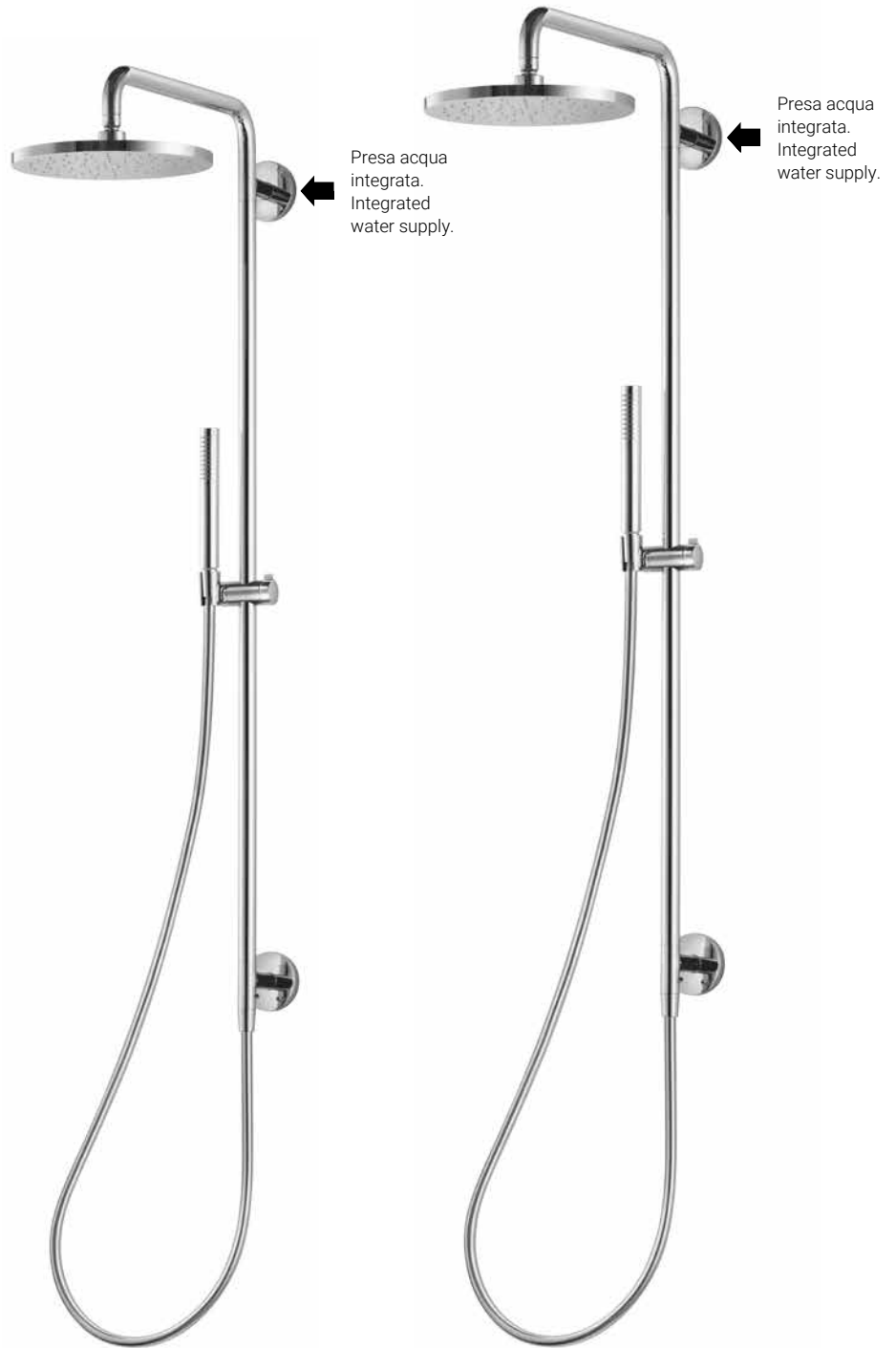

Pres a acqua
integrata.
Integrated
water supply.

Pres a acqua
integrata.
Integrated
water supply.

-  **CR** Cromo | Chrome
-  **OR** Oro | Gold
-  **VO** Vecchio Ottone | Old Brass
-  **VR** Vecchio Rame | Old Copper
-  **NS** Nickel Spazzolato | Satin Nickel

ANDROMEDA 90 con SCIROCCO e doccia ottone

ANDROMEDA 120 con SCIROCCO e doccia ottone

Colonna doccia in ottone Ø 24mm. Per installazione con gruppo incasso o esterno (non fornito). Completa di deviatore con alimentazione acqua dall'alto. Soffione doccia con snodo. Doccia monogetto anticalcare. Flessibile con attacco conico girevole, lunghezza 150cm.

Brass shower column diameter 24mm complete with deviator and high water supply. Shower head with swivel ball. Antiscale single-jet handshower. Flexible hose with swivel conical connection. Length 150cm.



Design ufficio tecnico Aquaviva
Design by Aquaviva's technical office



COLONNA COMPLETA _ COMPLETE SHOWER COLUMN

Finiture speciali su richiesta _ Special finishing on request

VALVE INOX TONDO

Ø 25
ACCIAIO INOX



SCIROCCO

Ø 20
ABS



PENELOPE

Ø 25
ACCIAIO INOX



Senza rubinetto
90 cm.

40070CR90

40080CR90

40090CR90

Senza rubinetto
120 cm.

40070CR120

40080CR120

40090CR120

* Specificare attacco rubinetto: 1/2" o 3/4".
Specify connection tap: 1/2" o 3/4".

Specificare interasse rubinetto-muro.
Specify distance centre tap-wall.

Per una corretta scelta consultare le note tecniche di pag. 94.
For a correct choice, consult the technical notes on pag. 94.

 Peso del tubo: kg. 2.0
Weight of the tube: kg. 2.0

Dettagli tecnici Dettagli tecnici

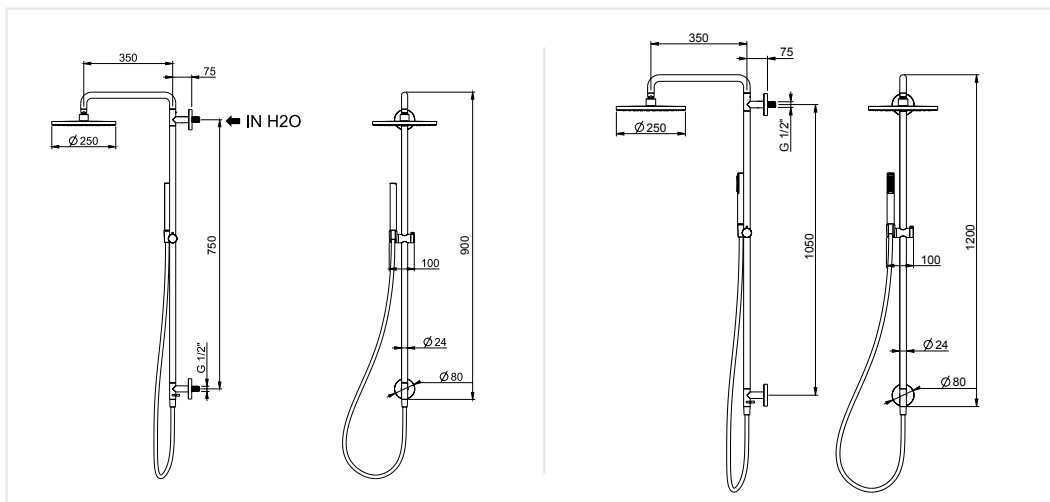



colonna TOPAZIO con soffione PERICLE - finitura oro

TOPAZIO



 **CR** Cromo | Chrome

 **OR** Oro | Gold

TOPAZIO con NETTUNO

Colonna doccia in ottone \square 24 mm. Soffione doccia con snodo. Doccia monogetto CUBE anticalcare regolabile in altezza. Flessibile doppia aggraffatura con attacco conico girevole, lunghezza 150 cm.

Brass shower column \square 24 mm. Head shower with swivel ball. Adjustable for height antiscaling single jet shower CUBE. Flexible hose with swivel conical connection, length 150 cm.



TOPAZIO

Rubinetteria abbinabile / *Combinable taps*



Termostatico quadro.
Interasse 150 mm.
Square thermostatic mixer.
Interaxis distance 150 mm.



Monocomando quadro.
Interasse 150 mm.
Square mixer.
Interaxis distance 150 mm



Termostatico quadro.
Square thermostatic mixer..

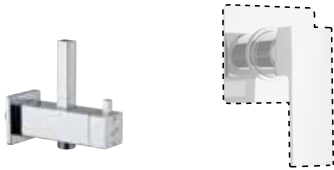

Preso acqua per installazione con monocomando o termostato a incasso già esistente (non fornito).
Water supply for installation with concealed shower mixer.
Mixer not included.



Preso acqua quadra special per alimentazione esterna.
Special water supply for external water inlet.

Dettagli tecnici

Dettagli tecnici

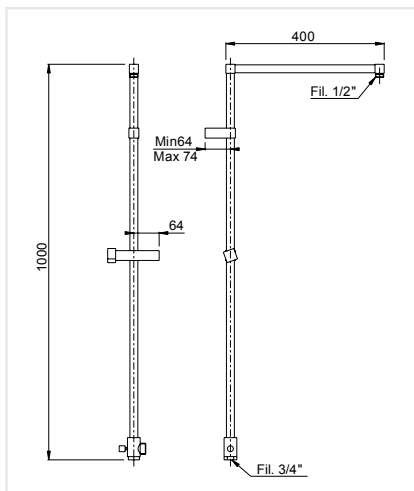

COLONNA COMPLETA _ COMPLETE SHOWER COLUMN

Finiture speciali su richiesta _ Special finishing on request



NETTUNO
20 x 20
ACCIAIO INOX CROMO



PERICLE
25 x 25
ACCIAIO INOX



BORA
20 x 20
ABS



**VALVE INOX
QUADRO**
25 x 25
ACCIAIO INOX



* Senza rubinetto



30101CR

30103CR

30104CR

30107CR

Monocomando quadro



30141CR

30143CR

30144CR

30147CR

Termostatico quadro



30121CR

30123CR

30124CR

30127CR

Preso acqua quadra



30161CR

30163CR

30164CR

30167CR

Preso acqua quadra special



30061CR

30063CR

30064CR

30067CR

* Specificare attacco rubinetto: 1/2" o 3/4".
Specify connection tap: 1/2" o 3/4".

Specificare interasse rubinetto-muro.
Specify distance centre tap-wall.

Per una corretta scelta consultare le note tecniche di pag. 94.
For a correct choice, consult the technical notes on pag. 94.

 Peso del tubo: kg. 3.8
Weight of the tube: kg. 3.8







colonna GIADA con soffione PENELOPE - finitura nickel spazzolato

GIADA



GIADA con DELTA con portasapone crystal

-  **CR** Cromo | Chrome
-  **OR** Oro | Gold
-  **VO** Vecchio Ottone | Old Brass
-  **VR** Vecchio Rame | Old Copper
-  **NS** Nickel Spazzolato | Satin Nickel

Colonna doccia in ottone Ø 18 mm alta 125 cm completa di deviatore. Soffione doccia con snodo. Braccio Ø 21 mm lungh. 35 cm. Doccia monogetto anticalcare regolabile in altezza. Flessibile doppia aggraffatura con attacco conico girevole, lunghezza 150 cm.

Brass shower column Ø 18 mm height 125 cm complete with diverter. Head shower with swivel ball. Brass shower arm Ø 21 mm length 35 cm. Adjustable for height antiscald single jet shower. Double interlock flexible hose swivel conical connection, length 150 cm.



GIADA

Rubinetteria abbinabile / *Combinable taps*



Termostatico da barra.
Interasse 150 mm.
Thermostatic mixer.
interaxis distance 150 mm.

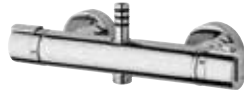

Termostatico MINIMAL.
Interasse 150 mm.
MINIMAL thermostatic mixer.
Interaxis distance 150 mm.



Gruppo monocomando.
Interasse 150 mm.
Mixer. Interaxis distance 150 mm.



Preso acqua per installazione con monocomando o termostato a incasso già esistente (non fornito).
Water supply for installation with concealed shower mixer.
Mixer not included.



Preso acqua tonda special per alimentazione esterna.
Round special water supply for external water inlet.

Portasapone a richiesta

Soap tray on request



Dettagli tecnici

Dettagli tecnici

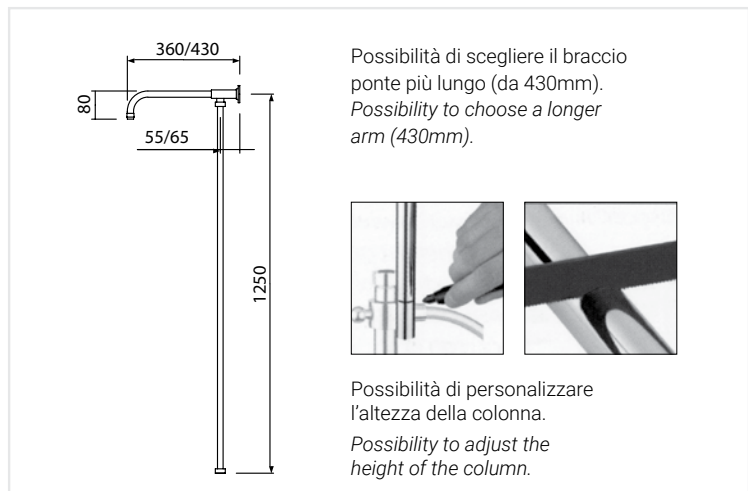

COLONNA COMPLETA _ COMPLETE SHOWER COLUMN

Finiture speciali su richiesta _ Special finishing on request



DELTA
Ø 20
ACCIAIO INOX CROMO



SCIROCCO
Ø 20
ABS



PENELOPE
Ø 25
ACCIAIO INOX



VALVE INOX TONDO
Ø 25
ACCIAIO INOX



* Senza rubinetto



32105CR

32108CR

32107CR

32109CR

Gruppo monocomando



32155CR

32158CR

32157CR

32159CR

Termostatico da barra



32135CR

32138CR

32137CR

32139CR

Termostatico MINIMAL



32175CR

32178CR

32177CR

32179CR

Presacqua c/ deviatore integrato



32165CR

32168CR

32167CR

32169CR

Presacqua tonda special



32065CR

32068CR

32067CR

32069CR

* Specificare attacco rubinetto: 1/2" o 3/4".
Specify connection tap: 1/2" o 3/4".

Specificare interasse rubinetto-muro.
Specify distance centre tap-wall.

Per una corretta scelta consultare le note tecniche di pag. 94.
For a correct choice, consult the technical notes on pag. 94.

 Peso del tubo: kg. 3.8
Weight of the tube: kg. 3.8



colonna GEMMA con soffione PENELOPE - finitura nero

GEMMA

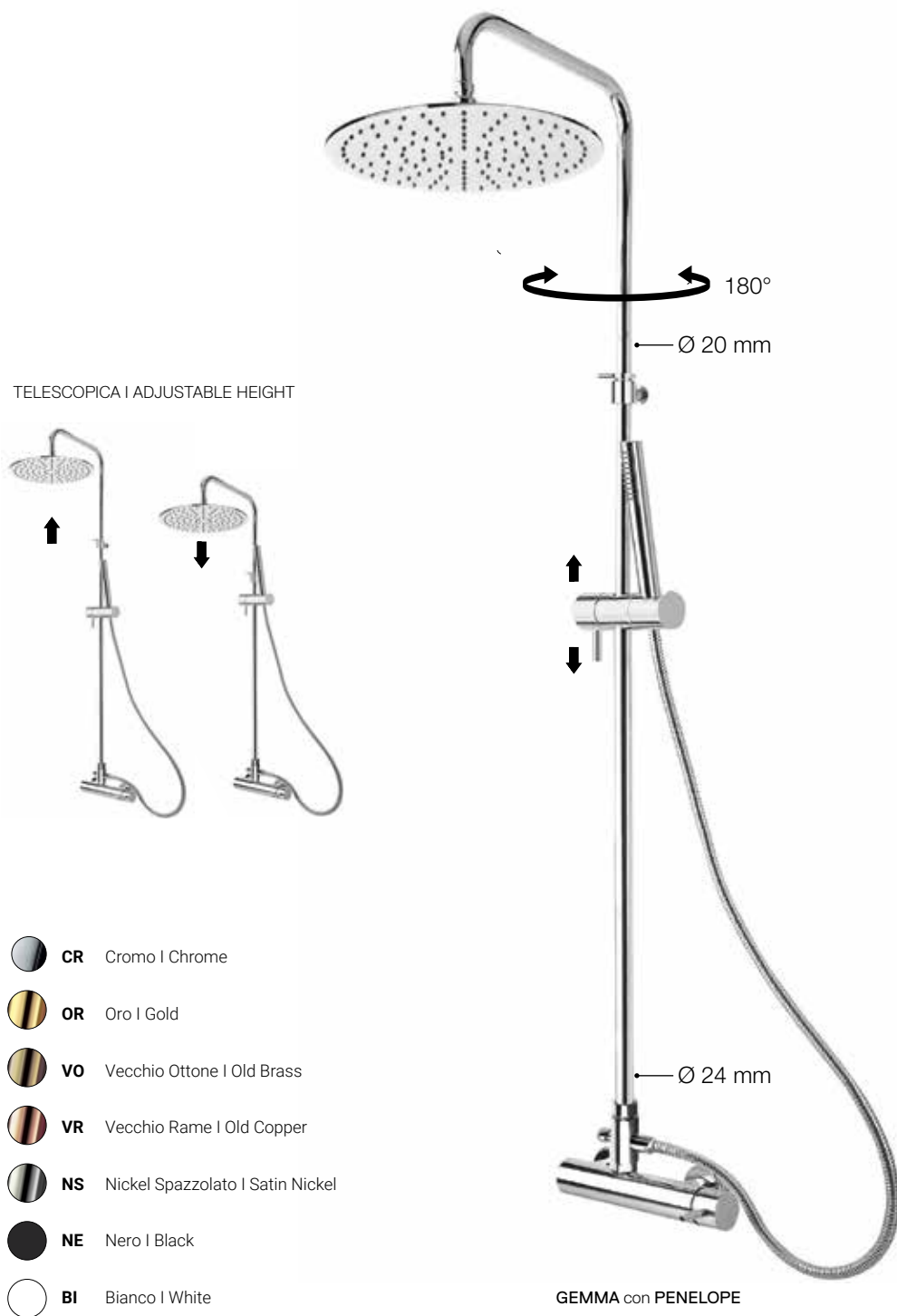

Colonna doccia in ottone Ø 24 mm regolabile in altezza da 68 a 120 cm completa di deviatore. Soffione doccia con snodo. Doccia monogetto anticalcare. Supporto portadoccia scorrevole. Flessibile doppia aggraffatura con attacco conico girevole, lunghezza 150 cm.

Adjustable brass shower column Ø 24 mm height from 68 to 120 cm complete with diverter. Head shower with swivel ball. Antiscale single jet shower adjustable for height. Double interlock flexible hose swivel conical connection, length 150 cm.



GEMMA

Rubinetteria abbinabile / *Combinable taps*



Termostatico da barra.
Interasse 150 mm.
Thermostatic mixer.
interaxis distance 150 mm.



Termostatico MINIMAL.
Interasse 150 mm.
MINIMAL thermostatic mixer.
Interaxis distance 150 mm.



Gruppo monocomando.
Interasse 150 mm.
Mixer. Interaxis distance 150 mm.



Preso acqua per installazione con monocomando o termostato a incasso già esistente (non fornito).
Water supply for installation with concealed shower mixer. Mixer not included.



Preso acqua tonda special per alimentazione esterna.
Round special water supply for external water inlet.

Dettagli tecnici

Dettagli tecnici

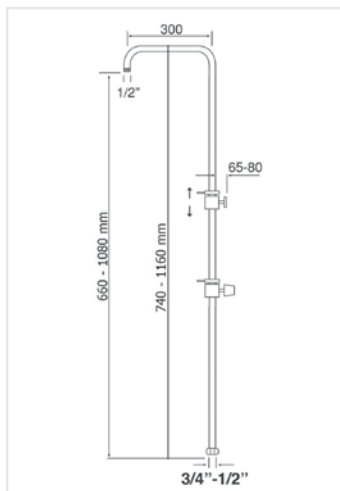

COLONNA COMPLETA _ COMPLETE SHOWER COLUMN

Finiture speciali su richiesta _ Special finishing on request



PENELOPE
Ø 25
ACCIAIO INOX



VALVE INOX TONDO
Ø 25
ACCIAIO INOX



NEW MERCURY
ANTICALCARE Ø 20
OTTONE



SCIROCCO
Ø 20
ABS



* Senza rubinetto		35107CR	35104CR	35101CR	35105CR
Termostatico da barra		35137CR	35134CR	35131CR	35135CR
Termostatico MINIMAL		35177CR	35174CR	35171CR	35175CR
Gruppo monocomando		35197CR	35194CR	35191CR	35195CR
Pres a acqua c/ deviatore integrato		35167CR	35164CR	35161CR	35165CR
Pres a acqua tonda special		35187CR	35184CR	35181CR	35185CR

* Specificare attacco rubinetto: 1/2" o 3/4".
Specify connection tap: 1/2" o 3/4".

Specificare interasse rubinetto-muro.
Specify distance centre tap-wall.

Per una corretta scelta consultare le note tecniche di pag. 94.
For a correct choice, consult the technical notes on pag. 94.





 Peso del tubo: kg. 2.3
Weight of the tube: kg. 2.3



colonna AMBRA con soffione MERCURY - finitura nero

AMBRA



-  **CR** Cromo | Chrome
-  **OR** Oro | Gold
-  **VO** Vecchio Ottone | Old Brass
-  **VR** Vecchio Rame | Old Copper
-  **NS** Nickel Spazzolato | Satin Nickel

AMBRA con NEW MERCURY

Colonna doccia in ottone Ø 18 mm alta 125 cm completa di deviatore. Soffione doccia con snodo. Braccio Ø 21 mm lunghezza 35 cm. Doccia monogetto regolabile in altezza. Flessibile doppia aggraffatura con attacco conico girevole, lunghezza 150 cm.

Brass shower column Ø 18 mm height 125 cm complete with diverter. Head shower with swivel ball. Brass shower arm Ø 21 mm length 35 cm. Adjustable for height single jet shower. Double interlock flexible hose with swivel conical connection, length 150 cm.



AMBRA

Rubinetteria abbinabile / *Combinable taps*



Gruppo classico.
Interasse 160 mm.
Classic group.
Interaxis distance 160 mm.



Termostatico da barra.
Interasse 150 mm.
Thermostatic mixer.
interaxis distance 150 mm.



Termostatico MINIMAL.
Interasse 150 mm.
MINIMAL thermostatic mixer.
Interaxis distance 150 mm.



Gruppo monocomando.
Interasse 150 mm.
Mixer. Interaxis distance 150 mm.



Preso acqua per installazione con monocomando o termostato a incasso già esistente (non fornito).
Water supply for installation with concealed shower mixer.
Mixer not included.



Preso acqua tonda special per alimentazione esterna.
Round special water supply for external water inlet.

Portasapone a richiesta
Soap tray on request



Dettagli tecnici
Dettagli tecnici

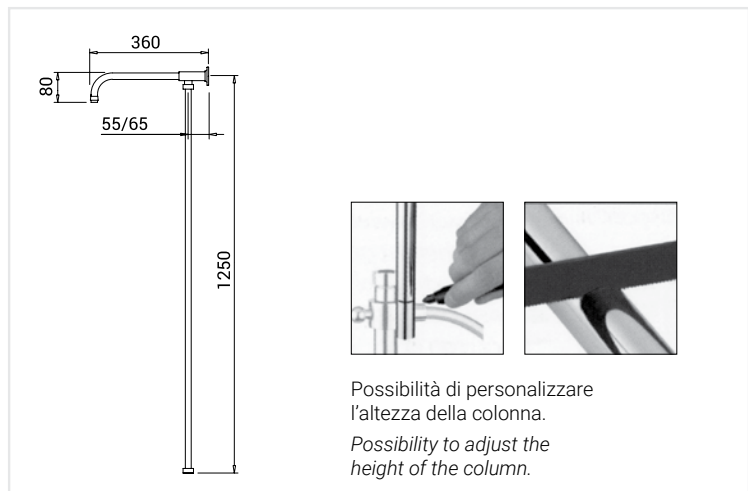

Possibilità di personalizzare l'altezza della colonna.
Possibility to adjust the height of the column.

COLONNA COMPLETA _ COMPLETE SHOWER COLUMN

Finiture speciali su richiesta _ Special finishing on request



NEW MERCURY
ANTICALCARE Ø 20
OTTONE



PENELOPE
Ø 25
ACCIAIO INOX



SCIROCCO
Ø 20
ABS



VALVE INOX TONDO
Ø 25
ACCIAIO INOX



* Senza rubinetto



31101CR

31106CR

31105CR

31107CR

Gruppo classico



31111CR

31116CR

31115CR

31117CR

Gruppo monocomando



31171CR

31176CR

31175CR

31177CR

Termostatico da barra



31131CR

31136CR

31135CR

31137CR

Termostatico MINIMAL



31121CR

31126CR

31125CR

31127CR

Pres a acqua c/ deviatore integrato



31161CR

31166CR

31165CR

31167CR

Pres a acqua tonda special



31061CR

31066CR

31065CR

31067CR

* Specificare attacco rubinetto: 1/2" o 3/4".
Specify connection tap: 1/2" o 3/4".

Specificare interasse rubinetto-muro.
Specify distance centre tap-wall.





Per una corretta scelta consultare le note tecniche di pag. 94.
For a correct choice, consult the technical notes on pag. 94.

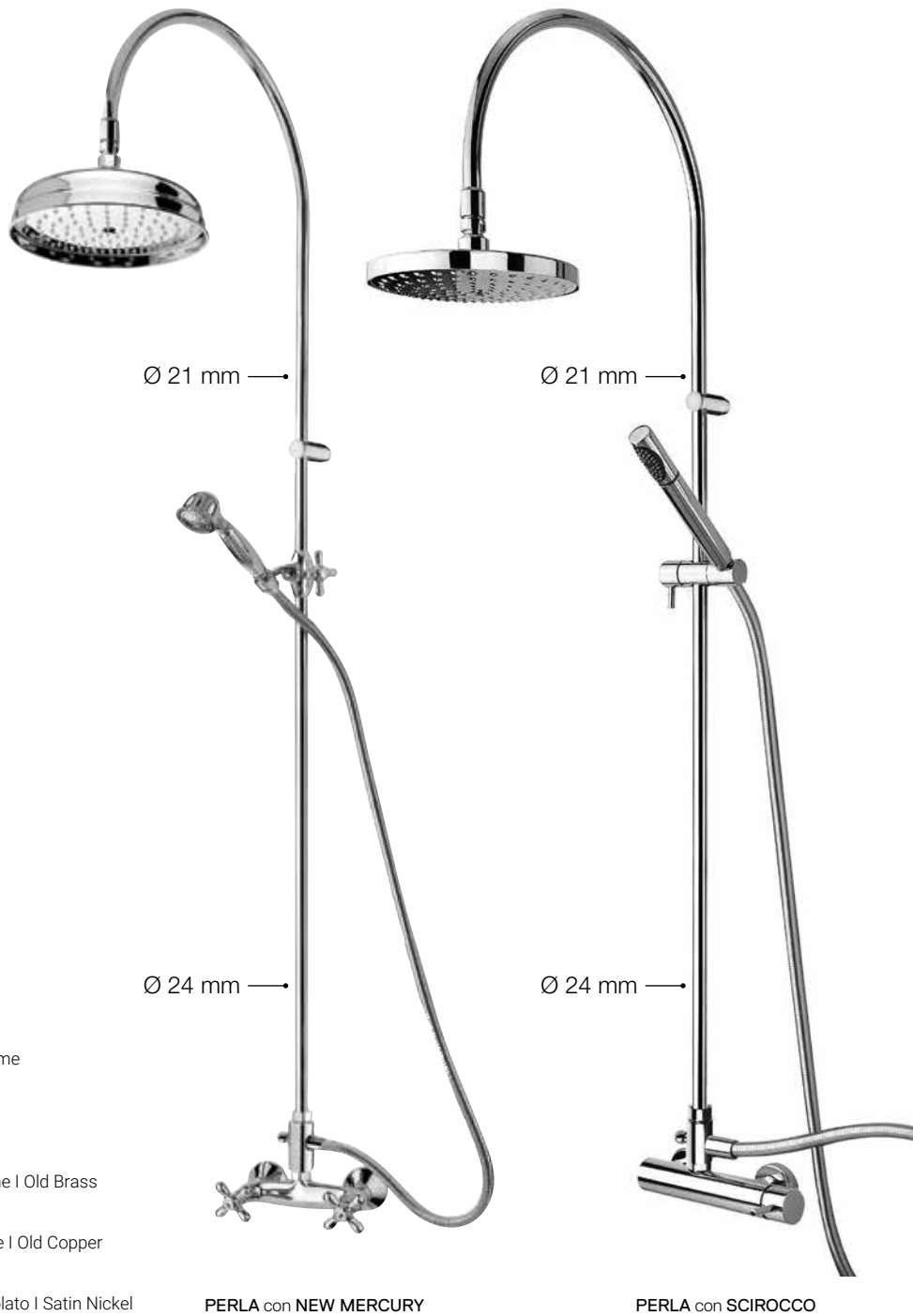

colonna PERLA con soffione DISCO - finitura cromo

PERLA



-  **CR** Cromo | Chrome
-  **OR** Oro | Gold
-  **VO** Vecchio Ottone | Old Brass
-  **VR** Vecchio Rame | Old Copper
-  **NS** Nickel Spazzolato | Satin Nickel

PERLA con NEW MERCURY

PERLA con SCIROCCO

Colonna doccia telescopica in ottone Ø 24 mm altezza totale 140 cm completa di deviatore. Soffione doccia con snodo. Doccia monogetto anticalcare regolabile in altezza. Flessibile cromolux con attacco conico girevole, lunghezza 150 cm.

Brass telescopic shower column Ø 24 mm. Total height 140 cm complete with diverter. Head shower with swivel ball. Adjustable for height antiscalc single jet shower. Cromolux flexible hose with swivel conical connection, length 150 cm.



PERLA

Rubinetteria abbinabile / *Combinable taps*



Gruppo classico.
Interasse 160 mm.
Classic group.
Interaxis distance 160 mm.



Termostatico da barra.
Interasse 150 mm.
Thermostatic mixer.
interaxis distance 150 mm.

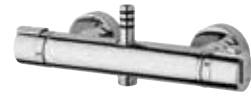

Termostatico MINIMAL.
Interasse 150 mm.
MINIMAL thermostatic mixer.
Interaxis distance 150 mm.



Gruppo monocomando.
Interasse 150 mm.
Mixer. Interaxis distance 150 mm.



Preso acqua per installazione con monocomando o termostato a incasso già esistente (non fornito).
Water supply for installation with concealed shower mixer. Mixer not included.



Preso acqua tonda special per alimentazione esterna.
Round special water supply for external water inlet.

Dettagli tecnici

Dettagli tecnici

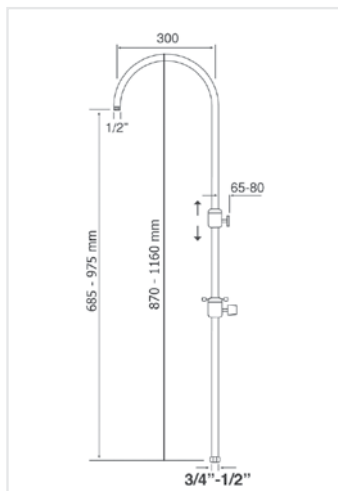

COLONNA COMPLETA _ COMPLETE SHOWER COLUMN

Finiture speciali su richiesta _ Special finishing on request



SCORREVOLE CLASSICO



NEW MERCURY
ANTICALCARE Ø 20
OTTONE



SCORREVOLE MODERNO



PENELOPE
Ø 25
ACCIAIO INOX



SCORREVOLE MODERNO



SCIROCCO
Ø 20
ABS



SCORREVOLE MODERNO



VALVE INOX TONDO
Ø 25
ACCIAIO INOX



* Senza rubinetto



34105CR

34108CR

34101CR

34102CR

Gruppo classico



34185CR

34188CR

34181CR

34182CR

Gruppo monocomando



34195CR

34198CR

34191CR

34192CR

Termostatico da barra



34135CR

34138CR

34131CR

34132CR

Termostatico MINIMAL



34175CR

34178CR

34171CR

34172CR

Preso acqua c/ deviatore integrato



34165CR

34168CR

34161CR

34162CR

Preso acqua tonda special



34085CR

34088CR

34081CR

34082CR

* Specificare attacco rubinetto: 1/2" o 3/4".
Specify connection tap: 1/2" o 3/4".

Specificare interasse rubinetto-muro.
Specify distance centre tap-wall.





Per una corretta scelta consultare le note tecniche di pag. 94.
For a correct choice, consult the technical notes on pag. 94.



colonna **SMERALDO Q** con soffione **NETTUNO** - finitura cromo

SMERALDO Q



-  **CR** Cromo | Chrome
-  **OR** Oro | Gold
-  **VO** Vecchio Ottone | Old Brass
-  **VR** Vecchio Rame | Old Copper
-  **NS** Nickel Spazzolato | Satin Nickel

SMERALDO Q con NETTUNO

Colonna doccia in ottone Ø 24 mm regolabile in altezza da 68 a 120 cm completa di deviatore. Soffione doccia con snodo. Doccia monogetto anticalcare. Supporto portadoccia scorrevole. Flessibile doppia aggraffatura con attacco conico girevole, lunghezza 150 cm.

Adjustable brass shower column Ø 24 mm height from 68 to 120 cm complete with diverter. Head shower with swivel ball. Antiscale single jet shower adjustable for height. Double interlock flexible hose swivel conical connection, length 150 cm.



SMERALDO Q

Rubinetteria abbinabile / *Combinable taps*



Monocomando quadro.
Interasse 150 mm.
Square mixer.
Interaxis distance 150 mm



Termostatico quadro.
Square thermostatic mixer.



Termostatico da barra quadro.
Interasse 150 mm.
Square thermostatic mixer.
Interaxis distance 150 mm.

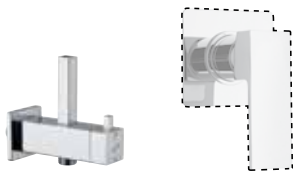

Presa acqua per installazione con monocomando o termostato a incasso già esistente (non fornito).
Water supply for installation with concealed shower mixer. Mixer not included.



Presa acqua quadra special per alimentazione esterna.
Special water supply for external water inlet.

Dettagli tecnici

Dettagli tecnici

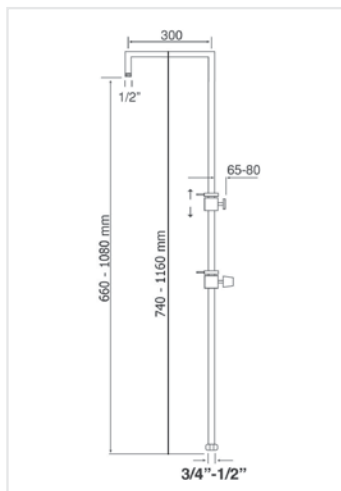

COLONNA COMPLETA _ COMPLETE SHOWER COLUMN

Finiture speciali su richiesta _ Special finishing on request



NETTUNO
20 x 20
ACCIAIO INOX



LYRAE
24 x 36
ABS



PERICLE
25 x 25
ACCIAIO INOX



**VALVE INOX
QUADRO**
25 x 25
ACCIAIO INOX



* Senza
rubinetto



38105CR

38107CR

38106CR

38108CR

Termostatico
da barra quadro



38195CR

38197CR

38196CR

38198CR

Monocomando
quadro



38145CR

38147CR

38146CR

38148CR

Preso acqua
c/ deviatore
integrato



38185CR

38187CR

38186CR

38188CR

Preso acqua
tonda special



38085CR

38087CR

38086CR

38088CR

* Specificare attacco rubinetto: 1/2" o 3/4".
Specify connection tap: 1/2" o 3/4".

Specificare interasse rubinetto-muro.
Specify distance centre tap-wall.

Per una corretta scelta consultare le note tecniche di pag. 94.
For a correct choice, consult the technical notes on pag. 94.





 Peso del tubo: kg. 2.0
Weight of the tube: kg. 2.0

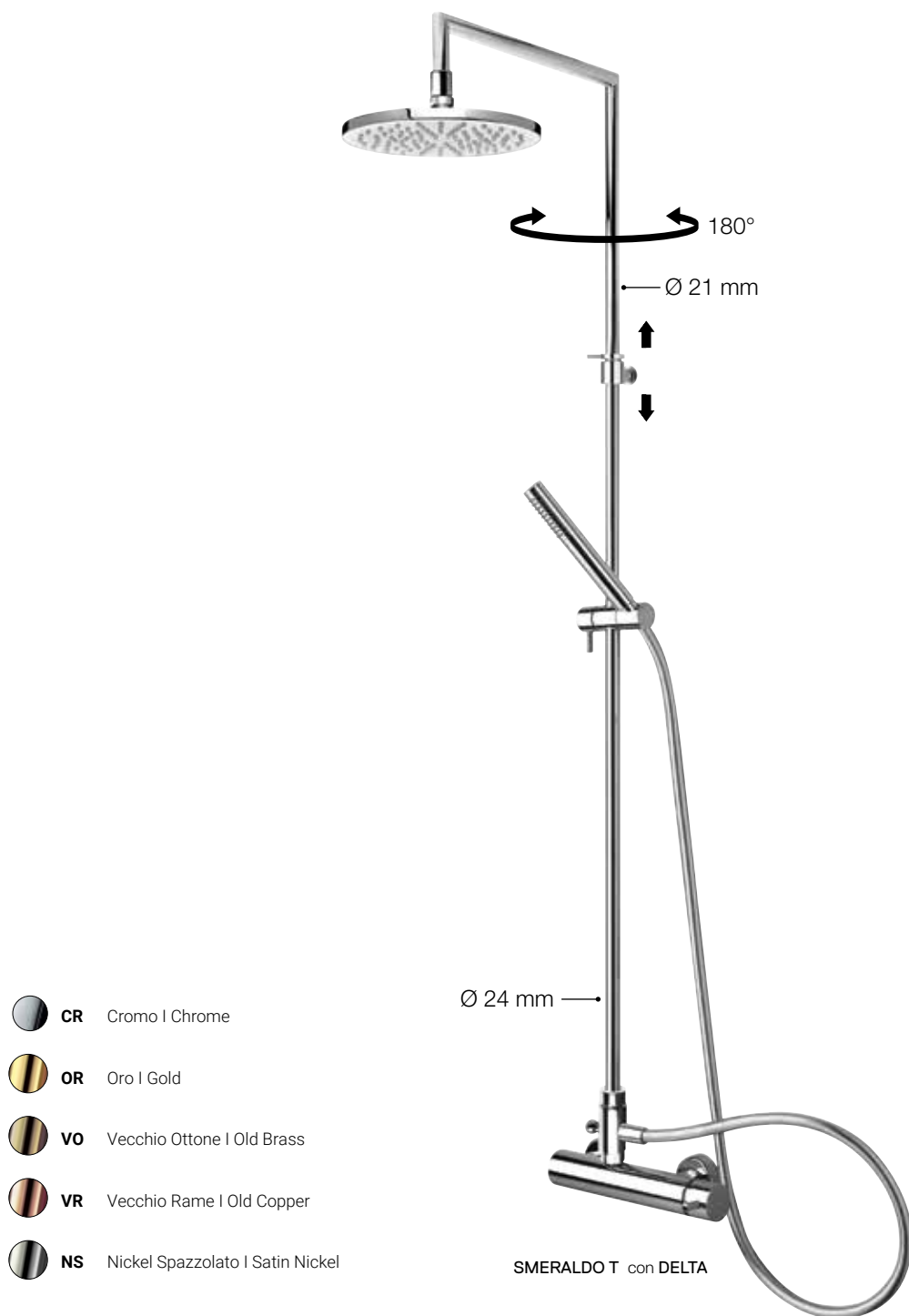

colonna SMERALDO T con soffione DELTA - finitura cromo

SMERALDO T



-  **CR** Cromo | Chrome
-  **OR** Oro | Gold
-  **VO** Vecchio Ottone | Old Brass
-  **VR** Vecchio Rame | Old Copper
-  **NS** Nickel Spazzolato | Satin Nickel

SMERALDO T con DELTA

Colonna doccia in ottone Ø 24 mm regolabile in altezza da 68 a 120 cm completa di deviatore. Soffione doccia con snodo. Doccia monogetto anticalcare. Supporto portadoccia scorrevole. Flessibile doppia aggraffatura con attacco conico girevole, lunghezza 150 cm.

Adjustable brass shower column Ø 24 mm height from 68 to 120 cm complete with diverter. Head shower with swivel ball. Antiscale single jet shower adjustable for height. Double interlock flexible hose swivel conical connection, length 150 cm.



SMERALDO T

Rubinetteria abbinabile / *Combinable taps*



Termostatico da barra.
Interasse 150 mm.
Thermostatic mixer.
interaxis distance 150 mm.

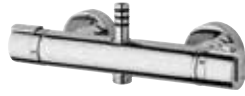

Termostatico MINIMAL.
Interasse 150 mm.
MINIMAL thermostatic mixer.
Interaxis distance 150 mm.



Gruppo monocomando.
Interasse 150 mm.
Mixer. Interaxis distance 150 mm.



Preso acqua per installazione con monocomando o termostato a incasso già esistente (non fornito).
Water supply for installation with concealed shower mixer. Mixer not included.



Preso acqua tonda special per alimentazione esterna.
Round special water supply for external water inlet.

Dettagli tecnici

Dettagli tecnici

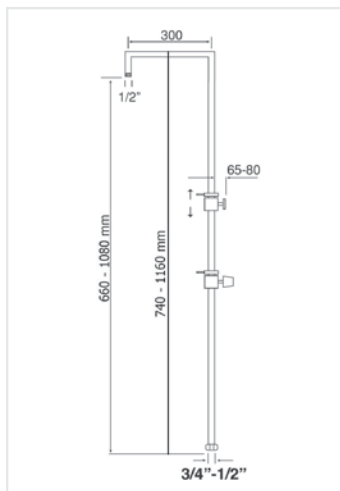

COLONNA COMPLETA _ COMPLETE SHOWER COLUMN

Finiture speciali su richiesta _ Special finishing on request



DELTA
Ø 20
ACCIAIO INOX



SCIROCCO
Ø 20
ABS



PENELOPE
Ø 25
ACCIAIO INOX



**VALVE INOX
TONDO**
Ø 25
ACCIAIO INOX



* Senza
rubinetto



38101CR

38109CR

38104CR

38102CR

Termostatico
da barra



38131CR

38139CR

38134CR

38132CR

Termostatico
MINIMAL



38171CR

38179CR

38174CR

38172CR

Gruppo
monocomando



38121CR

38129CR

38124CR

38122CR

Preso acqua
c/ deviatore
integrato



38161CR

38169CR

38164CR

38162CR

Preso acqua
tonda special



38061CR

38069CR

38064CR

38062CR

* Specificare attacco rubinetto: 1/2" o 3/4".
Specify connection tap: 1/2" o 3/4".

Specificare interasse rubinetto-muro.
Specify distance centre tap-wall.

Per una corretta scelta consultare le note tecniche di pag. 94.
For a correct choice, consult the technical notes on pag. 94.





 Peso del tubo: kg. 2.0
Weight of the tube: kg. 2.0



colonna ZAFFIRO con soffione DELTA - finitura cromo

ZAFFIRO T



-  **CR** Cromo | Chrome
-  **OR** Oro | Gold
-  **VO** Vecchio Ottone | Old Brass
-  **VR** Vecchio Rame | Old Copper
-  **NS** Nickel Spazzolato | Satin Nickel

ZAFFIRO T con DELTA e doccia ottone

Colonna doccia telescopica in ottone
 Ø 24 mm. Altezza totale 125 cm completa di
 deviatore. Soffione doccia con snodo. Doccia
 monogetto anticalcare regolabile in altezza.
 Flessibile cromolux con attacco conico girevole,
 lunghezza 150 cm.

*Brass telescopic shower column Ø 24 mm.
 Total height 125 cm complete with diverter.
 Head shower with swivel ball. Adjustable for
 height antiscalc single jet shower. Cromolux
 flexible hose with swivel conical connection,
 length 150 cm.*



ZAFFIRO T

Rubinetteria abbinabile / *Combinable taps*



Termostatico da barra.
Interasse 150 mm.
Thermostatic mixer.
interaxis distance 150 mm.

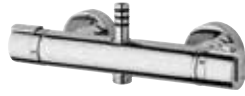

Termostatico MINIMAL.
Interasse 150 mm.
MINIMAL thermostatic mixer.
Interaxis distance 150 mm.



Gruppo monocomando.
Interasse 150 mm.
Mixer. Interaxis distance 150 mm.



Presa acqua per installazione con monocomando o termostato a incasso già esistente (non fornito).
Water supply for installation with concealed shower mixer.
Mixer not included.



Presa acqua tonda special per alimentazione esterna.
Round special water supply for external water inlet.

Dettagli tecnici

Dettagli tecnici

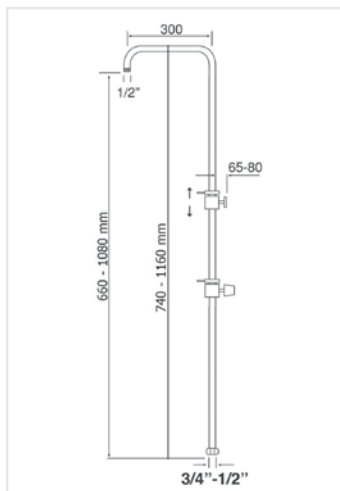

COLONNA COMPLETA _ COMPLETE SHOWER COLUMN

Finiture speciali su richiesta _ Special finishing on request



**VALVE INOX
TONDO**
Ø 25
ACCIAIO INOX



SCIROCCO
Ø 20
ABS



PENELOPE
Ø 25
ACCIAIO INOX



* Senza rubinetto



36100CR

36107CR

36103CR

Termostatico da barra



36130CR

36137CR

36133CR

Termostatico MINIMAL



36170CR

36177CR

36173CR

Gruppo monocomando moderno



36180CR

36187CR

36183CR

Preso acqua c/ deviatore integrato



36160CR

36167CR

36163CR

Preso acqua tonda special



36060CR

36067CR

36063CR

* Specificare attacco rubinetto: 1/2" o 3/4".
Specify connection tap: 1/2" o 3/4".

Specificare interasse rubinetto-muro.
Specify distance centre tap-wall.

Per una corretta scelta consultare le note tecniche di pag. 94.
For a correct choice, consult the technical notes on pag. 94.





 Peso del tubo: kg. 2.0
Weight of the tube: kg. 2.0

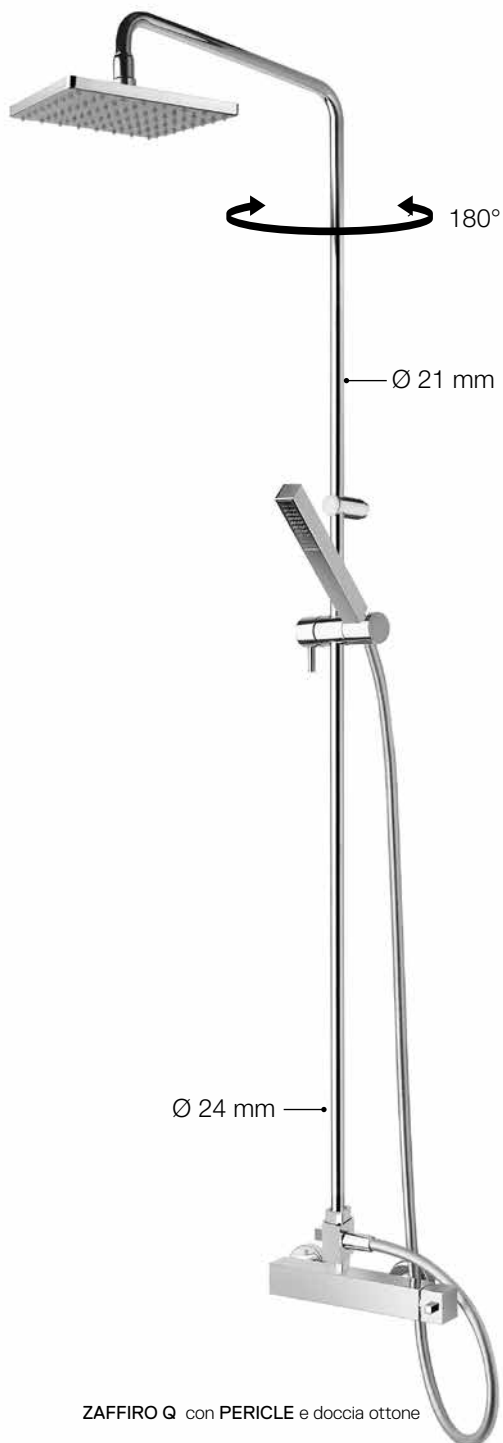

colonna ZAFFIRO Q - finitura cromo

ZAFFIRO Q



-  **CR** Cromo | Chrome
-  **OR** Oro | Gold
-  **VO** Vecchio Ottone | Old Brass
-  **VR** Vecchio Rame | Old Copper
-  **NS** Nickel Spazzolato | Satin Nickel

ZAFFIRO Q con PERICLE e doccia ottone

Colonna doccia telescopica in ottone Ø 24 mm. Altezza totale 125 cm completa di deviatore. Soffione doccia con snodo. Doccia monogetto anticalcare regolabile in altezza. Flessibile cromolux con attacco conico girevole, lunghezza 150 cm.

Brass telescopic shower column Ø 24 mm. Total height 125 cm complete with diverter. Head shower with swivel ball. Adjustable for height antiscalc single jet shower. Cromolux flexible hose with swivel conical connection, length 150 cm.



ZAFFIRO Q

Rubinetteria abbinabile / *Combinable taps*



Monocomando quadro.
Interasse 150 mm.
Square mixer.
Interaxis distance 150 mm



Termostatico da barra quadro.
Interasse 150 mm.
Square thermostatic mixer.
Interaxis distance 150 mm.

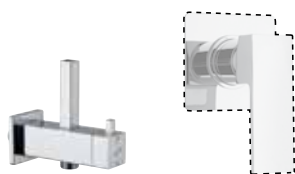

Preso acqua per installazione con monocomando o termostato a incasso già esistente (non fornito).
Water supply for installation with concealed shower mixer.
Mixer not included.



Preso acqua quadra special per alimentazione esterna.
Special water supply for external water inlet.

Dettagli tecnici

Dettagli tecnici

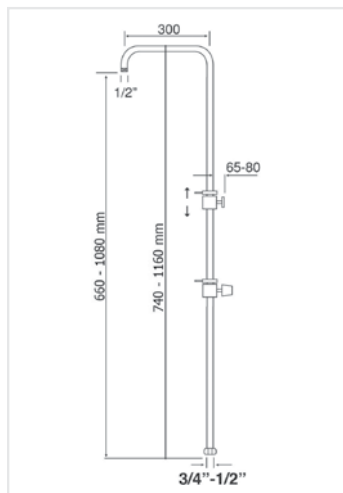

COLONNA COMPLETA _ COMPLETE SHOWER COLUMN

Finiture speciali su richiesta _ Special finishing on request



BORA
20 x 20
ABS



PERICLE
25 x 25
ACCIAIO INOX



**VALVE INOX
QUADRO**
25 x 25
ACCIAIO INOX



* Senza rubinetto



36108CR

36109CR

36106CR

Termostatico da barra quadro



36138CR

36139CR

36136CR

Monocomando quadro



36188CR

36189CR

36186CR

Pres a acqua c/ deviatore integrato



36168CR

36169CR

36166CR

Pres a acqua tonda special



36068CR

36069CR

36066CR

* Specificare attacco rubinetto: 1/2" o 3/4".
Specify connection tap: 1/2" o 3/4".

Specificare interasse rubinetto-muro.
Specify distance centre tap-wall.

Per una corretta scelta consultare le note tecniche di pag. 94.
For a correct choice, consult the technical notes on pag. 94.





 Peso del tubo: kg. 2.0
Weight of the tube: kg. 2.0

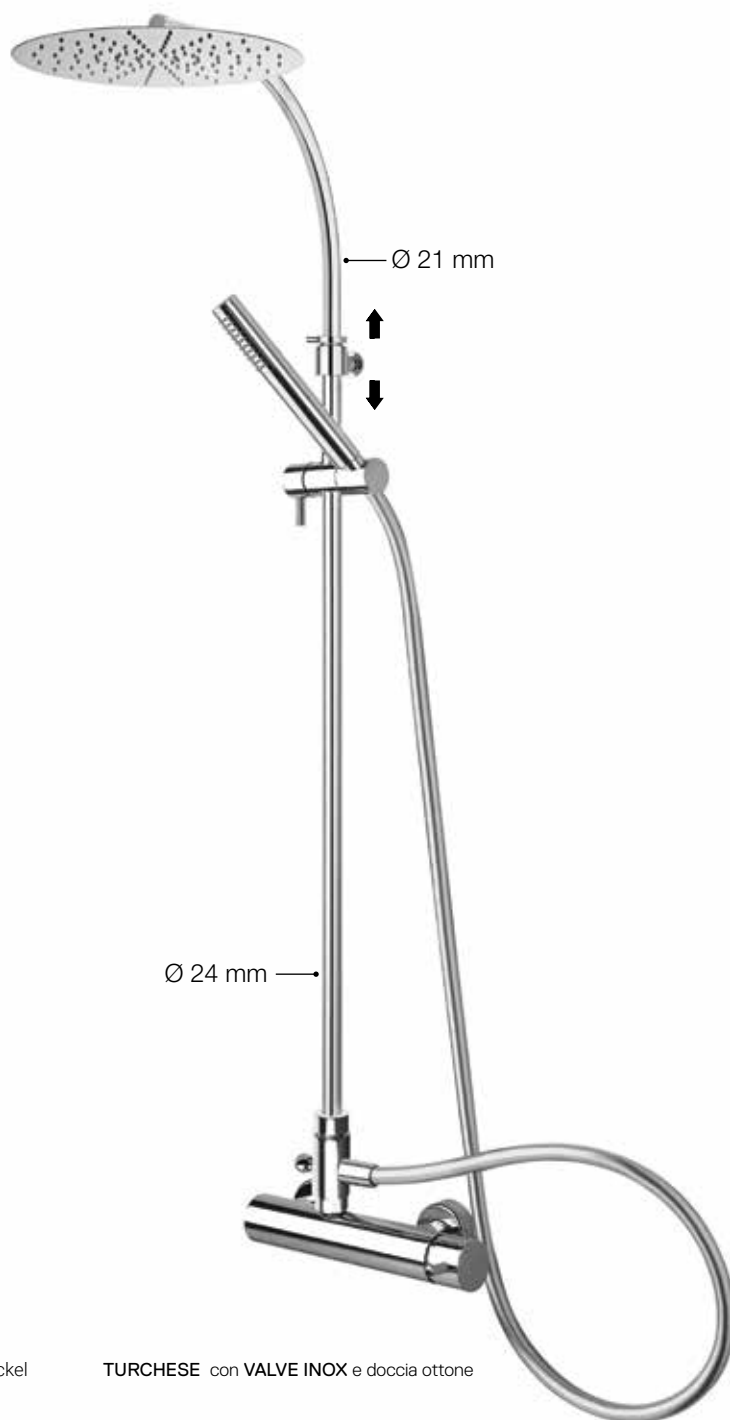

colonna TURCHESE - finitura cromo

TURCHESE



-  **CR** Cromo | Chrome
-  **OR** Oro | Gold
-  **VO** Vecchio Ottone | Old Brass
-  **VR** Vecchio Rame | Old Copper
-  **NS** Nickel Spazzolato | Satin Nickel

TURCHESE con VALVE INOX e doccia ottone

Colonna doccia in ottone Ø 24 mm. Altezza totale 125 cm completa di deviatore. Soffione doccia con snodo. Doccia monogetto anticalcare regolabile in altezza. Flessibile cromolux con attacco conico girevole, lunghezza 150 cm.

Brass shower column Ø 24 mm. Total height 125 cm complete with diverter. Head shower with swivel ball. Adjustable for height antiscald single jet shower. Cromolux flexible hose with swivel conical connection, length 150 cm.



TURCHESE

Rubinetteria abbinabile / *Combinable taps*



Termostatico MINIMAL.
Interasse 150 mm.

*MINIMAL thermostatic mixer.
Interaxis distance 150 mm.*



Gruppo monocomando.
Interasse 150 mm.

Mixer. Interaxis distance 150 mm.



Presa acqua per installazione con monocomando o
termostato a incasso già esistente (non fornito).

*Water supply for installation with concealed shower mixer.
Mixer not included.*



Presa acqua tonda special
per alimentazione esterna.

*Round special water supply
for external water inlet.*

Dettagli tecnici

Dettagli tecnici

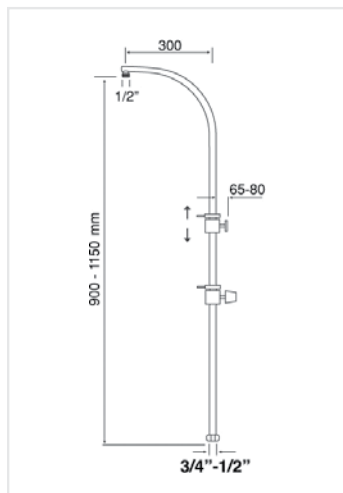

COLONNA COMPLETA _ COMPLETE SHOWER COLUMN

Finiture speciali su richiesta _ Special finishing on request



**VALVE INOX
TONDO**
Ø 25
ACCIAIO INOX



SCIROCCO
Ø 20
ABS



PENELOPE
Ø 25
ACCIAIO INOX



* Senza
rubinetto



37109CR

37108CR

37107CR

Termostatico
MINIMAL



37179CR

37178CR

37177CR

Gruppo
monocomando
moderno



37159CR

37158CR

37157CR

Preso acqua
c/ deviatore
integrato



37169CR

37168CR

37167CR

Preso acqua
tonda special



37069CR

37068CR

37067CR

* Specificare attacco rubinetto: 1/2" o 3/4".
Specify connection tap: 1/2" o 3/4".

Specificare interasse rubinetto-muro.
Specify distance centre tap-wall.

Per una corretta scelta consultare le note tecniche di pag. 94.
For a correct choice, consult the technical notes on pag. 94.

 Peso del tubo: kg. 2.0
Weight of the tube: kg. 2.0

LINEA ECO

ECO LINE



MARE E MONTI con SCIROCCO



ICE con ULTRAPIATTO



SNELLA con ULTRAPIATTO



ICE con ULTRAPIATTO



colonna MARE E MONTI con soffione SCIROCCO - finitura cromo

MARE E MONTI



76131CR
MARE E MONTI con SCIROCCO



76136CR
MARE E MONTI con ULTRAPIATTO



76132CR
MARE E MONTI con BORA

 **CR** Cromo I Chrome

Tubazione spessore 1 mm.
Scorrevole portadoccia in ABS cromato.

*Thickness tube 1 mm.
ABS sliding bar shower holder.*



Design ufficio tecnico Aquaviva
Design by Aquaviva's technical office



MARE E MONTI

Dettagli tecnici

Dettagli tecnici

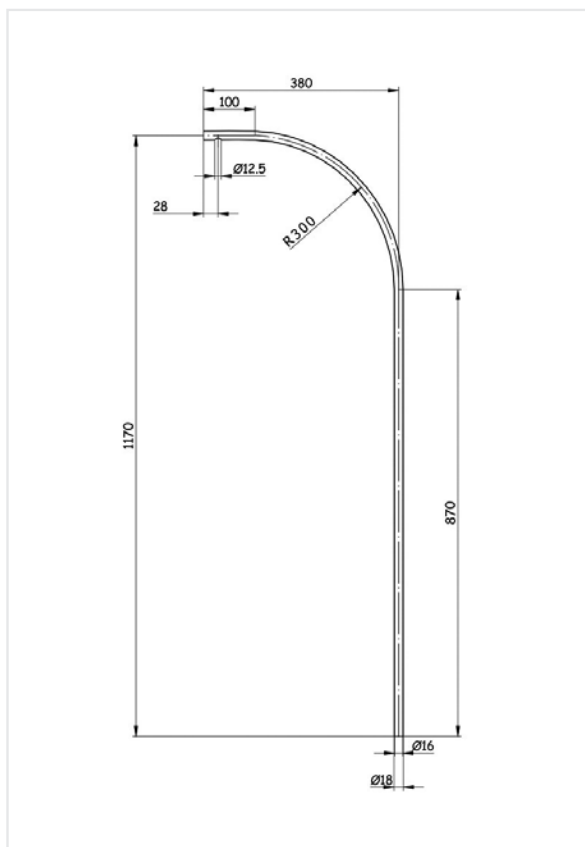

Portasapone a richiesta

Soap tray on request



Possibilità di tagliare la tubazione.

Possibility to adjust the height of the column.

COLONNA COMPLETA _ COMPLETE SHOWER COLUMN

Finiture speciali su richiesta _ Special finishing on request

COMBINAZIONI POSSIBILI
POSSIBLE COMBINATIONS



76131CR

Colonna Mari e Monti con tubazione in OTTONE Ø18, termostatico, soffione SCIROCCO Ø200 in ABS cromato e ispezionabile, doccetta monogetto.

76195CR

Colonna Mari e Monti con tubazione in OTTONE Ø18, monocomando, soffione SCIROCCO Ø200 in ABS cromato e ispezionabile, doccetta monogetto.

76161CR

Colonna Mari e Monti con tubazione in OTTONE Ø18, presa acqua per installazione con incasso (non fornito), soffione SCIROCCO Ø200 in ABS cromato e ispezionabile, doccetta monogetto.

76181CR

Colonna Mari e Monti con tubazione in OTTONE Ø18, presa acqua special per installazione su rubinetto con alimentazione esterna e doppio flessibile, soffione SCIROCCO Ø200 in ABS cromato e ispezionabile, doccetta monogetto.



76136CRV

Colonna Mari e Monti con tubazione in OTTONE Ø18, termostatico, soffione ACCIAIO con valvola di sicurezza di sicurezza, doccetta monogetto.

76196CRV

Colonna Mari e Monti con tubazione in OTTONE Ø18, monocomando, soffione ACCIAIO con valvola di sicurezza, doccetta monogetto.

76166CRV

Colonna Mari e Monti con tubazione in OTTONE Ø18, presa acqua per installazione con incasso (non fornito), soffione ACCIAIO con valvola di sicurezza, doccetta monogetto.

76186CRV

Colonna Mari e Monti con tubazione in OTTONE Ø18, presa acqua special per installazione su rubinetto con alimentazione esterna e doppio flessibile, soffione ACCIAIO con valvola di sicurezza, doccetta monogetto.



con valvola di sicurezza



76136CRE

Colonna Mari e Monti con tubazione in OTTONE Ø18, termostatico, soffione ACCIAIO non ispezionabile, doccetta monogetto.

76196CRE

Colonna Mari e Monti con tubazione in OTTONE Ø18, monocomando, soffione ACCIAIO non ispezionabile, doccetta monogetto.

76166CRE

Colonna Mari e Monti con tubazione in OTTONE Ø18, presa acqua per installazione con incasso (non fornito), soffione ACCIAIO non ispezionabile, doccetta monogetto.

76186CRE

Colonna Mari e Monti con tubazione in OTTONE Ø18, presa acqua special per installazione su rubinetto con alimentazione esterna e doppio flessibile, soffione ACCIAIO non ispezionabile, doccetta monogetto.



76132CR

Colonna Mari e Monti con tubazione in OTTONE Ø18, termostatico, soffione BORA 200x200 in ABS cromato e ispezionabile, doccetta monogetto.

76192CR

Colonna Mari e Monti con tubazione in OTTONE Ø18, monocomando, soffione BORA 200x200 in ABS cromato e ispezionabile, doccetta monogetto.

76162CR

Colonna Mari e Monti con tubazione in OTTONE Ø18, presa acqua per installazione con incasso (non fornito), soffione BORA 200x200 in ABS cromato e ispezionabile, doccetta monogetto.

76182CR

Colonna Mari e Monti con tubazione in OTTONE Ø18, presa acqua special per installazione su rubinetto con alimentazione esterna e doppio flessibile, soffione BORA 200x200 in ABS cromato e ispezionabile, doccetta monogetto.



76137CRV

Colonna Mari e Monti con tubazione in OTTONE Ø18, termostatico, soffione ACCIAIO con valvola di sicurezza, doccetta monogetto.

76197CRV

Colonna Mari e Monti con tubazione in OTTONE Ø18, monocomando, soffione ACCIAIO con valvola di sicurezza, doccetta monogetto.

76167CRV

Colonna Mari e Monti con tubazione in OTTONE Ø18, presa acqua per installazione con incasso (non fornito), soffione ACCIAIO con valvola di sicurezza, doccetta monogetto.

76162CRV

Colonna Mari e Monti con tubazione in OTTONE Ø18, presa acqua special per installazione su rubinetto con alimentazione esterna e doppio flessibile, soffione ACCIAIO con valvola di sicurezza, doccetta monogetto.



con valvola di sicurezza



76137CRE

Colonna Mari e Monti con tubazione in OTTONE Ø18, termostatico, soffione ACCIAIO non ispezionabile, doccetta monogetto.

76197CRE

Colonna Mari e Monti con tubazione in OTTONE Ø18, monocomando, soffione ACCIAIO non ispezionabile, doccetta monogetto.

76167CRE

Colonna Mari e Monti con tubazione in OTTONE Ø18, presa acqua per installazione con incasso (non fornito), soffione ACCIAIO non ispezionabile, doccetta monogetto.

76162CRE

Colonna Mari e Monti con tubazione in OTTONE Ø18, presa acqua special per installazione su rubinetto con alimentazione esterna e doppio flessibile, soffione ACCIAIO non ispezionabile, doccetta monogetto.



colonna SNELLA con soffione ULTRAPIATTO - finitura cromo

SNELLA T - SNELLA Q



77131CR
SNELLA con SCIROCCO

77136CR
SNELLA con ULTRAPIATTO

77132CR
SNELLA con BORA

77137CR
SNELLA con ULTRAPIATTO

 **CR** Cromo / Chrome

Tubazione spessore 1 mm.
Scorrevole portadoccia in ABS cromato.

*Thickness tube 1 mm.
ABS sliding bar shower holder.*



Design ufficio tecnico Aquaviva
Design by Aquaviva's technical office



SNELLA T

Rubinetteria tonda / Round taps

Dettagli tecnici

Dettagli tecnici

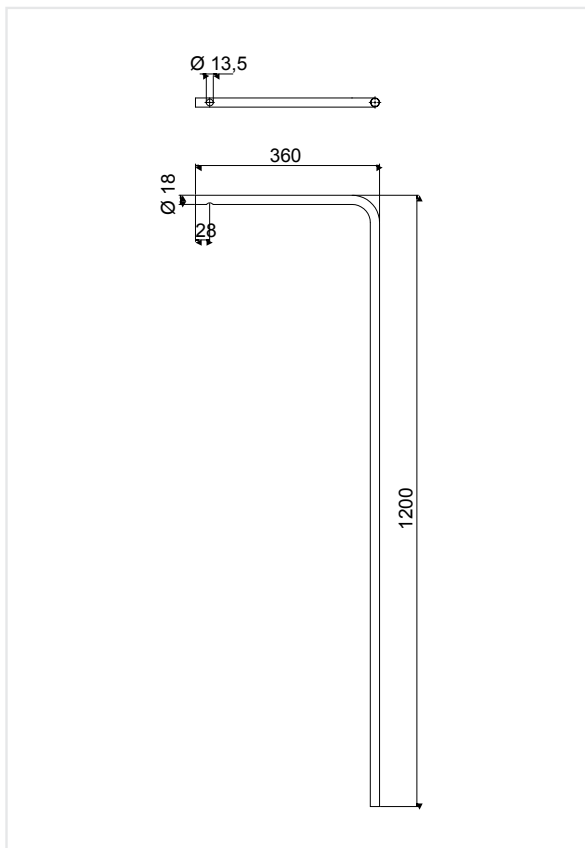

Portasapone a richiesta

Soap tray on request



Possibilità di tagliare la tubazione.

Possibility to adjust the height of the column.

COLONNA COMPLETA _ COMPLETE SHOWER COLUMN

Finiture speciali su richiesta _ Special finishing on request

COMBINAZIONI POSSIBILI
POSSIBLE COMBINATIONS



77131CR

Colonna Snella con tubazione in OTTONE Ø18, termostatico, soffione SCIROCCO Ø200 in ABS cromato e ispezionabile, doccetta monogetto.



77191CR

Colonna Snella con tubazione in OTTONE Ø18, monocomando, soffione SCIROCCO Ø200 in ABS cromato e ispezionabile, doccetta monogetto.

77161CR

Colonna Snella con tubazione in OTTONE Ø18, presa acqua per installazione con incasso (non fornito), soffione SCIROCCO Ø200 in ABS cromato e ispezionabile, doccetta monogetto.

77181CR

Colonna Snella con tubazione in OTTONE Ø18, presa acqua special per installazione su rubinetto con alimentazione esterna e doppio flessibile, soffione SCIROCCO Ø200 in ABS cromato e ispezionabile, doccetta monogetto.

77136CRV

Colonna Snella con tubazione in OTTONE Ø18, termostatico, soffione ACCIAIO con valvola di sicurezza, doccetta monogetto.



77196CRV

Colonna Snella con tubazione in OTTONE Ø18, monocomando, soffione ACCIAIO con valvola di sicurezza, doccetta monogetto.

77166CRV

Colonna Snella con tubazione in OTTONE Ø18, presa acqua per installazione con incasso (non fornito), soffione ACCIAIO con valvola di sicurezza, doccetta monogetto.

77186CRV

Colonna Snella con tubazione in OTTONE Ø18, presa acqua special per installazione su rubinetto con alimentazione esterna e doppio flessibile, soffione ACCIAIO con valvola di sicurezza, doccetta monogetto.



con valvola di sicurezza

77136CRE

Colonna Snella con tubazione in OTTONE Ø18, termostatico, soffione ACCIAIO non ispezionabile, doccetta monogetto.



77196CRE

Colonna Snella con tubazione in OTTONE Ø18, monocomando, soffione ACCIAIO non ispezionabile, doccetta monogetto.

77166CRE

Colonna Snella con tubazione in OTTONE Ø18, presa acqua per installazione con incasso (non fornito), soffione ACCIAIO non ispezionabile, doccetta monogetto.

77186CRE

Colonna Snella con tubazione in OTTONE Ø18, presa acqua special per installazione su rubinetto con alimentazione esterna e doppio flessibile, soffione ACCIAIO non ispezionabile, doccetta monogetto.

77132CR

Colonna Snella con tubazione in OTTONE Ø18, termostatico, soffione BORA 200x200 in ABS cromato e ispezionabile, doccetta monogetto.



77192CR

Colonna Snella con tubazione in OTTONE Ø18, monocomando, soffione BORA 200x200 in ABS cromato e ispezionabile, doccetta monogetto.

77162CR

Colonna Snella con tubazione in OTTONE Ø18, presa acqua per installazione con incasso (non fornito), soffione BORA 200x200 in ABS cromato e ispezionabile, doccetta monogetto.

77182CR

Colonna Snella con tubazione in OTTONE Ø18, presa acqua special per installazione su rubinetto con alimentazione esterna e doppio flessibile, soffione BORA 200x200 in ABS cromato e ispezionabile, doccetta monogetto.

77137CRV

Colonna Snella con tubazione in OTTONE Ø18, termostatico, soffione ACCIAIO con valvola di sicurezza, doccetta monogetto.



77197CRV

Colonna Snella con tubazione in OTTONE Ø18, monocomando, soffione ACCIAIO con valvola di sicurezza, doccetta monogetto.

77167CRV

Colonna Snella con tubazione in OTTONE Ø18, presa acqua per installazione con incasso (non fornito), soffione ACCIAIO con valvola di sicurezza, doccetta monogetto.

77162CRV

Colonna Snella con tubazione in OTTONE Ø18, presa acqua special per installazione su rubinetto con alimentazione esterna e doppio flessibile, soffione ACCIAIO con valvola di sicurezza, doccetta monogetto.



con valvola di sicurezza

77137CRE

Colonna Snella con tubazione in OTTONE Ø18, termostatico, soffione ACCIAIO non ispezionabile, doccetta monogetto.



77197CRE

Colonna Snella con tubazione in OTTONE Ø18, monocomando, soffione ACCIAIO non ispezionabile, doccetta monogetto.

77167CRE

Colonna Snella con tubazione in OTTONE Ø18, presa acqua per installazione con incasso (non fornito), soffione ACCIAIO non ispezionabile, doccetta monogetto.

77162CRE

Colonna Snella con tubazione in OTTONE Ø18, presa acqua special per installazione su rubinetto con alimentazione esterna e doppio flessibile, soffione ACCIAIO non ispezionabile, doccetta monogetto.

SNELLA Q

Rubinetteria quadra / Square taps

Dettagli tecnici

Dettagli tecnici

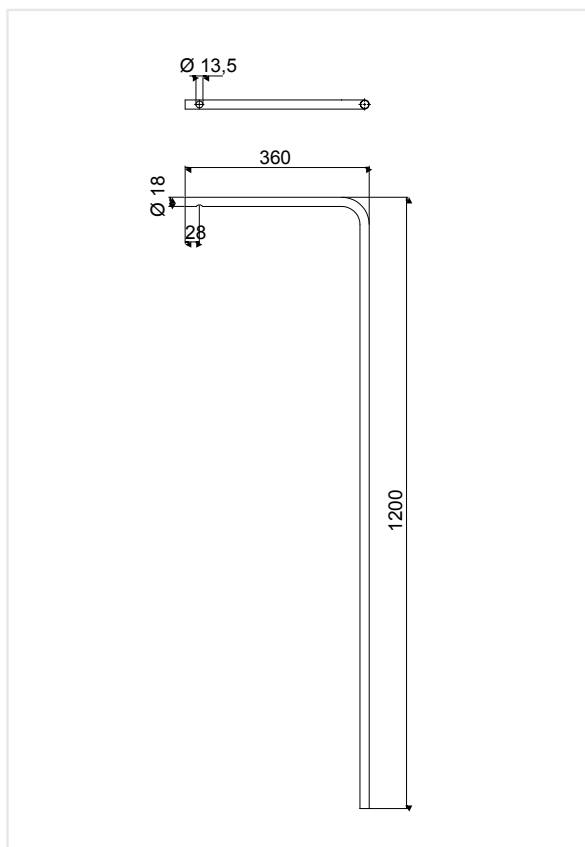

Portasapone a richiesta

Soap tray on request



Possibilità di tagliare la tubazione.

Possibility to adjust the height of the column.

COLONNA COMPLETA _ COMPLETE SHOWER COLUMN

Finiture speciali su richiesta _ Special finishing on request

COMBINAZIONI POSSIBILI
POSSIBLE COMBINATIONS**77138CR**

Colonna Snella con tubazione in OTTONE Ø18, termostatico, soffione BORA 200x200 in ABS cromato e ispezionabile, doccia monogetto.

**77198CR**

Colonna Snella con tubazione in OTTONE Ø18, monocomando, soffione BORA 200x200 in ABS cromato e ispezionabile, doccia monogetto.

77168CR

Colonna Snella con tubazione in OTTONE Ø18, presa acqua per installazione con incasso (non fornito), soffione BORA 200x200 in ABS cromato e ispezionabile, doccia monogetto.

77188CR

Colonna Snella con tubazione in OTTONE Ø18, presa acqua special per installazione su rubinetto con alimentazione esterna doppio flessibile, soffione BORA 200x200 in ABS cromato e ispezionabile, doccia monogetto.

77139CRV

Colonna Snella con tubazione in OTTONE Ø18, termostatico, soffione ACCIAIO con valvola di sicurezza, doccia monogetto.

**77199CRV**

Colonna Snella con tubazione in OTTONE Ø18, monocomando, soffione ACCIAIO con valvola di sicurezza, doccia monogetto.

77169CRV

Colonna Snella con tubazione in OTTONE Ø18, presa acqua per installazione con incasso (non fornito), soffione ACCIAIO con valvola di sicurezza, doccia monogetto.

77189CRV

Colonna Snella con tubazione in OTTONE Ø18, presa acqua special per installazione su rubinetto con alimentazione esterna doppio flessibile, soffione ACCIAIO con valvola di sicurezza, doccia monogetto.



con valvola di sicurezza

77139CRE

Colonna Snella con tubazione in OTTONE Ø18, termostatico, soffione ACCIAIO non ispezionabile, doccia monogetto.

**77199CRE**

Colonna Snella con tubazione in OTTONE Ø18, monocomando, soffione ACCIAIO non ispezionabile, doccia monogetto.

77169CRE

Colonna Snella con tubazione in OTTONE Ø18, presa acqua per installazione con incasso (non fornito), soffione ACCIAIO non ispezionabile, doccia monogetto.

77189CRE

Colonna Snella con tubazione in OTTONE Ø18, presa acqua special per installazione su rubinetto con alimentazione esterna doppio flessibile, soffione ACCIAIO non ispezionabile, doccia monogetto.



colonna ICE con soffione ULTRAPIATTO - finitura cromo



ICE



CO35178CR



CO35179CR

-  **CR** Cromo | Chrome
-  **NE** Nero | Black

Tubazione spessore 1 mm. Scorrevole portadoccia in ABS cromato, telescopica e orientabile.

Thickness tube 1 mm. ABS sliding bar shower holder. TELESCOPIC AND SWIVELING.



Design ufficio tecnico Aquaviva
Design by Aquaviva's technical office



Dettagli tecnici

Dettagli tecnici

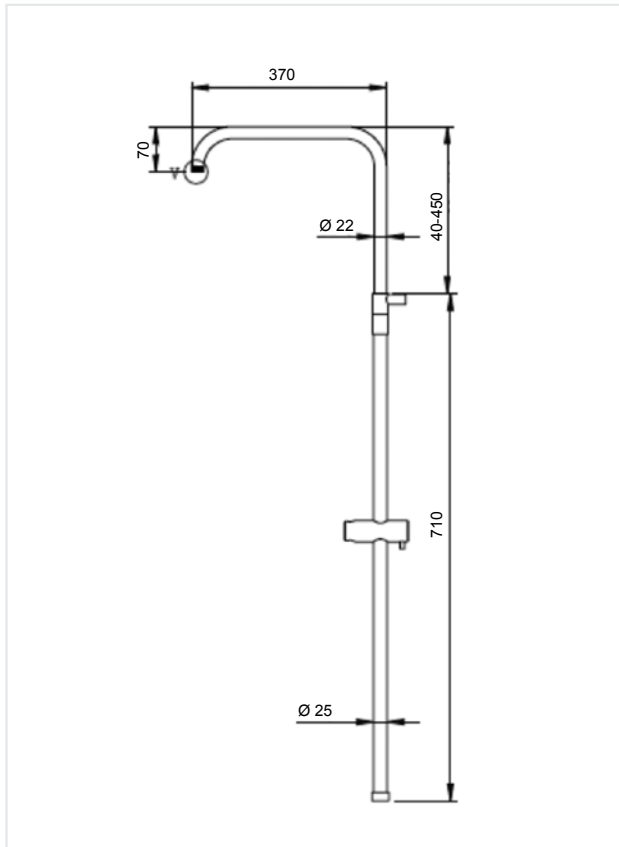

I soffioni sono disponibili anche con $\varnothing 20$.
The shower-heads are also available with $\varnothing 20$.

COLONNA COMPLETA _ COMPLETE SHOWER COLUMN

Finiture speciali su richiesta _ Special finishing on request

COMBINAZIONI POSSIBILI
POSSIBLE COMBINATIONS

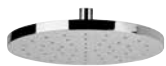

CO35178CR

Colonna ICE con tubazione in OTTONE Ø25, telescopica e orientabile, con termostatico, soffione ABS Ø200, doccetta monogetto.

CO35198CR

Colonna ICE con tubazione in OTTONE Ø25, telescopica e orientabile, con monocomando, soffione ABS Ø200, doccetta monogetto.

CO35168CR

Colonna ICE con tubazione in OTTONE Ø25, telescopica e orientabile, con presa acqua per installazione con incasso (non fornito), soffione ABS Ø200, doccetta monogetto.

CO35128CR

Colonna ICE con tubazione in ottone Ø18, presa acqua per installazione su rubinetto con alimentazione esterna e doppio flessibile, soffione Scirocco Ø200 in abs cromato e ispezionabile, doccetta monogetto.



CO35179CR

Colonna ICE con tubazione in OTTONE Ø25, telescopica e orientabile, con termostatico, soffione ABS 200x200, doccetta monogetto.

CO35199CR

Colonna ICE con tubazione in OTTONE Ø25, telescopica e orientabile, con monocomando, soffione ABS 200x200, doccetta monogetto.

CO35169CR

Colonna ICE con tubazione in OTTONE Ø25, telescopica e orientabile, con presa acqua per installazione con incasso (non fornito), soffione ABS 200x200, doccetta monogetto.

CO35129CR

Colonna ICE con tubazione in ottone Ø18, presa acqua per installazione su rubinetto con alimentazione esterna e doppio flessibile, soffione ABS con valvola di sicurezza, doccetta monogetto.



CO35172CRV

Colonna ICE con tubazione in OTTONE Ø25, telescopica e orientabile, con termostatico, soffione ACCIAIO con valvola di sicurezza Ø250, doccetta monogetto.

CO35192CRV

Colonna ICE con tubazione in OTTONE Ø25, telescopica e orientabile, con monocomando, soffione ACCIAIO con valvola di sicurezza Ø250, doccetta monogetto.

CO35162CRV

Colonna ICE con tubazione in OTTONE Ø25, telescopica e orientabile, con presa acqua per installazione con incasso (non fornito), soffione ACCIAIO con valvola di sicurezza Ø250, doccetta monogetto.

CO35122CRV

Colonna Ice con tubazione in OTTONE Ø18, presa acqua special per installazione su rubinetto con alimentazione esterna e doppio flessibile, soffione ACCIAIO con valvola di sicurezza, doccetta monogetto.



con valvola di sicurezza



CO35172CRE

Colonna ICE con tubazione in OTTONE Ø25, telescopica e orientabile, con termostatico, soffione ACCIAIO, doccetta monogetto.

CO35192CRE

Colonna ICE con tubazione in OTTONE Ø25, telescopica e orientabile, con monocomando, soffione ACCIAIO, doccetta monogetto.

CO35162CRE

Colonna ICE con tubazione in OTTONE Ø25, telescopica e orientabile, con presa acqua per installazione con incasso (non fornito), soffione ACCIAIO, doccetta monogetto.

CO35122CRE

Colonna ICE con tubazione in ottone Ø18, presa acqua per installazione su rubinetto con alimentazione esterna e doppio flessibile, soffione ACCIAIO, doccetta monogetto.



CO35179CRV

Colonna ICE con tubazione in OTTONE Ø25, telescopica e orientabile, con termostatico, soffione ACCIAIO con valvola di sicurezza, doccetta monogetto.

CO35199CRV

Colonna ICE con tubazione in OTTONE Ø25, telescopica e orientabile, con monocomando, soffione ACCIAIO con valvola di sicurezza, doccetta monogetto.

CO35169CRV

Colonna ICE con tubazione in OTTONE Ø25, telescopica e orientabile, con presa acqua per installazione con incasso (non fornito), soffione ACCIAIO con valvola di sicurezza, doccetta monogetto.

CO35121CRV

Colonna ICE con tubazione in ottone Ø18, presa acqua per installazione su rubinetto con alimentazione esterna e doppio flessibile, soffione ACCIAIO con valvola di sicurezza, doccetta monogetto.



con valvola di sicurezza

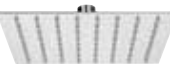

CO35179CRE

Colonna ICE con tubazione in OTTONE Ø25, telescopica e orientabile, con termostatico, soffione ACCIAIO non ispezionabile, doccetta monogetto.

CO35199CRE

Colonna ICE con tubazione in OTTONE Ø25, telescopica e orientabile, con monocomando, soffione ACCIAIO non ispezionabile, doccetta monogetto.

CO35169CRE

Colonna ICE con tubazione in OTTONE Ø25, telescopica e orientabile, con presa acqua per installazione con incasso (non fornito), soffione ACCIAIO non ispezionabile, doccetta monogetto.

CO35121CRE

Colonna ICE con tubazione in ottone Ø18, presa acqua per installazione su rubinetto con alimentazione esterna e doppio flessibile, soffione ACCIAIO non ispezionabile, doccetta monogetto.



cod. **66080CR**

Presa acqua per colonna tonda 2 vie.
2-ways water supply for round column.



cod. **66090CR**

Presa acqua per colonna quadra a 2 vie.
2-ways water supply for square column.



cod. **66022CR**

Presa acqua special tonda per alimentazione esterna.
Special water supply for external water inlet.



cod. **66095CR**

Presa acqua special quadraper alimentazione esterna.
Special water supply for external water inlet.



cod. **66020CR**

Presa acqua in ottone cromato per installazione con gruppo vasca.
Chromed brass water supply for installation with exposed bath mixer.



cod. **66010CR**

Presa acqua in ottone cromato per installazione con monocomando incasso.
Chromed brass water supply for installation with concealed shower mixer.



cod. **66060CR**

Deviatore in ottone cromato completo di raccordi per colonna.
Chromed brass diverter with connections for column.

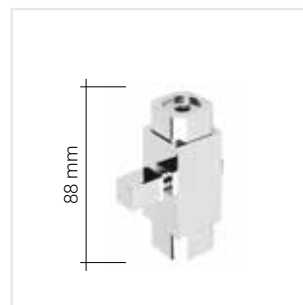

cod. **66064CR**

Deviatore in ottone cromato completo di raccordi per colonna.
Chromed brass diverter with connections for column.





cod. **66000CR**

Portasapone in ottone cromato per Ø 18 mm.
Chromed brass soap tray for Ø 18 mm.



156x88 mm



cod. **66070CR**

Portasapone in ottone cromato per Ø 18 mm.
Chromed brass soap tray for Ø 18 mm.



Ø 100 mm



cod. **50261TVT**

Portasapone in metacrilato trasparente speciale per colonne con tubazione Ø 18 mm, fornito con doppio supporto a muro.
Soap shelf, transparent methacrylate, round section Ø 18 mm.



310x135 mm

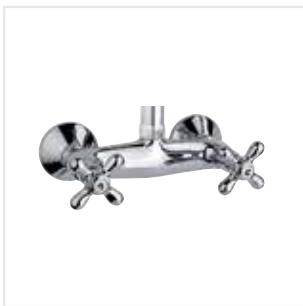

cod. **66165CR**



Gruppo classico.
Interasse 160 mm.
Classic group.
Interaxis distance 160 mm.

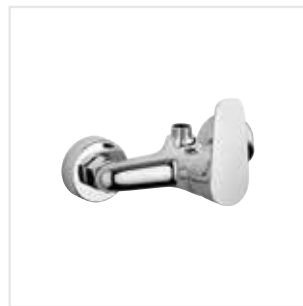

cod. **66133CR**



Gruppo monocomando
esterno per colonna.
Interasse 150 mm.
Mixer for columns.
Interaxis distance 150 mm.



cod. **66134CR**



Gruppo monocomando
moderno da fusione
per colonna.
Interasse 150 mm.
Mixer for modern columns.
Interaxis distance 150 mm.



cod. **66131CR**



Monocomando quadro per
colonna. Interasse 150 mm.
Square mixer for columns.
Interaxis distance 150 mm.



cod. **66400CR**



Termostatico MINIMAL con
deviatore integrato tondo per
colonna. Interasse 150 mm.
MINIMAL thermostatic mixer
with integrated diverter for
column. Interaxis distance
150 mm.



cod. **66100CR**



Termostatico tondo da barra
con deviatore integrato per
colonna. Interasse 150 mm.
Round thermostatic mixer
with integrated diverter for
columns. Interaxis distance
150 mm.



cod. **66300CR**



Termostatico da barra quadro
con deviatore integrato per
colonna. Interasse 150 mm.
Square thermostatic mixer
with integrated diverter for
columns. Interaxis distance
150 mm.



cod. **66500CR**



Termostatico quadro
MINIMAL con deviatore
integrato per colonna.
Interasse 150 mm.
MINIMAL square thermostatic
mixer with integrated diverter
for columns. Interaxis
distance 150 mm.



**65300CRT**

Cartuccia termostatica completa di maniglia cromata.
Thermostatic valve with chrome handle.

65300CRD

Cartuccia deviatrice completa di maniglia cromata.
Diverter valve with chrome handle.

65006

Cartuccia deviatrice in ottone (senza maniglia).
Brass diverter valve (without handle).

**65301CRT**

Cartuccia termostatica minimal completa di maniglia cromata.
Thermostatic valve with chrome handle.

65301CRD

Cartuccia deviatrice minimal completa di maniglia cromata.
Minimal diverter valve with chrome handle.

65006

Cartuccia deviatrice in ottone (senza maniglia).
Brass diverter valve (without handle).

**65302CRT**

Cartuccia termostatica completa di maniglia in metallo cromata.
Thermostatic valve with chrome handle.

65302CRD

Cartuccia deviatrice completa di maniglia in metallo cromata.
Diverter valve with chrome handle.

65006

Cartuccia deviatrice in ottone (senza maniglia).
Brass diverter valve (without handle).

**65304CRT**

Cartuccia termostatica minimal completa di maniglia in metallo cromata.
Thermostatic valve with chrome handle.

65304CRD

Cartuccia deviatrice minimal completa di maniglia in metallo cromata.
Minimal diverter valve with chrome handle.

65007

Cartuccia deviatrice in ABS (senza maniglia).
ABS diverter valve (without handle).

CARATTERISTICHE TECNICHE TERMOSTATICO THERMOSTATIC TECHNICAL CHARACTERISTICS

Temperatura di utilizzo <i>Operating temperature</i>	5°- 80° C
Gamma di regolazione della temperatura con ghiera graduata <i>Temperature setting range with graduated ring nut</i>	20°± 50° C
Temperatura per risparmio energetico <i>Temperature for energy saving</i>	60° C
Pressione di utilizzo <i>Operating pressure</i>	da 0,5 a 10 Bar
Pressione raccomandata <i>Recommended pressure</i>	da 1 a 4 Bar
Fermo di sicurezza <i>Safety catch</i>	38° C
Scala graduata manopola <i>Handle graduated scale</i>	da 20° a 50° C
Portata <i>Flow rate</i>	3 Bar 30 l/min

Interruzione flusso acqua: in caso di guasto idraulico garantisce l'interruzione del flusso d'acqua. Costanza temperatura: garanzia di temperatura costante con il variare della pressione dell'acqua.

Water flow interruption: in case of hydraulic failure it guarantees the interruption of the water flow. Constant temperature: guarantee of constant temperature with water pressure variation.

65250

Ricambio cartuccia monocomando Ø35 (bassa o alta).
Spare parts single lever Ø35 (low or high).

65251

Ricambio cartuccia monocomando Ø40 (bassa o alta).
Spare parts single lever Ø40 (low or high).

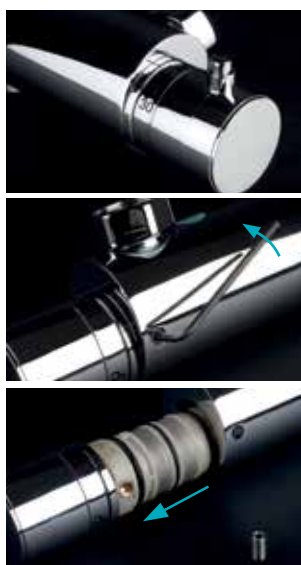

Corpo termostatico tornito da barra di ottone cromato di nostra produzione. Facilità e semplicità di sostituzione cartuccia. Si raccomanda di estrarre la cartuccia con la manopola montata per evitare di perdere la taratura
Chromed thermostatic body, brass bar turned, of our production. Easy replacement of the cartridge.







MANTERABS







Ricambio solo manopola in ABS | *ABS spare parts only handle*







MANTERMET

Ricambio solo manopola in metallo | *Metal spare parts only handle*

COME ORDINARE UNA COLONNA DOCCIA _ HOW TO ORDER A SHOWER COLUMN

		DELTA Ø 20 ACCIAIO INOX	SCIROCCO Ø 20 ABS	PENELOPE Ø 20 ACCIAIO INOX
Senza rubinetto		38101CR	38109CR	38104CR
Termostatico da barra		38131CR	38139CR	38134CR
Termostatico MINIMAL		38171CR	38179CR	38174CR
Gruppo monocomando		38121CR	38129CR	38124CR
Pres a acqua c/ deviatore integrato		38161CR	38169CR	38164CR
Pres a acqua tonda special		38061CR	38069CR	38064CR

		DELTA Ø 20 ACCIAIO INOX	SCIROCCO Ø 20 ABS	PENELOPE Ø 20 ACCIAIO INOX
Senza rubinetto		38101CR	38109CR	38104CR
Termostatico da barra		38131CR	38139CR	38134CR
Termostatico MINIMAL		38171CR	38179CR	38174CR
Gruppo monocomando		38121CR	38129CR	38124CR
Pres a acqua c/ deviatore integrato		38161CR	38169CR	38164CR
Pres a acqua tonda special		38061CR	38069CR	38064CR

		DELTA Ø 20 ACCIAIO INOX	SCIROCCO Ø 20 ABS	PENELOPE Ø 20 ACCIAIO INOX
Senza rubinetto		38101CR	38109CR	38104CR
Termostatico da barra		38131CR	38139CR	38134CR
Termostatico MINIMAL		38171CR	38179CR	38174CR
Gruppo monocomando		38121CR	38129CR	38124CR
Pres a acqua c/ deviatore integrato		38161CR	38169CR	38164CR
Pres a acqua tonda special		38061CR	38069CR	38064CR

1

Scegliere il modello di **rubinetto** desiderato tra quelli proposti.

Esempio: Termostatico da barra

*Choose the desired **tap** among the models proposed.*

For example: Thermostatic mixer

2

Scegliere il modello di **soffione** desiderato tra i modelli da noi proposti nei diversi materiali:

- ABS cromato
- Acciaio inox
- Ottone cromato

Esempio: Soffione disco Ø 20 cm

*Choose the desired **shower head** among the models proposed in the different materials:*

- Chromed ABS
- Stainless steel
- Chromed brass

For example: Disco Ø 20 cm shower head

3

Incrociare quanto evidenziato e indicare il codice corrispondente per la trasmissione dell'ordine.

Esempio: codice ordine

38139CR = Monocomando da barra + soffione disco Ø 20 cm

Crossing these informations, find corresponding code

For example:

38139CR = Mixer + disco Ø 20 cm shower head

NOTA: È possibile cambiare modello soffione o doccia scegliendo tra altri articoli inseriti nei capitoli dedicati.

NOTE: It is possible to replace the shower head or the hand shower with the models listed in the related sections.

ESEMPI COMBINAZIONI DOCCIA _ EXAMPLE OF COMBINATIONS

TONDO
ROUNDQUADRO
SQUARE

COLONNA SENZA RUBINETTO:

Colonna completa dotata di soffione, portadoccetta, doccia, flessibile 150 cm, deviatore con attacco 1/2" o 3/4" per installazione su miscelatore esterno con uscita superiore.

SHOWER COLUMN WITHOUT TAP:

Shower column equipped with shower head, hand shower holder, hand shower, flexible hose 150 cm, diverter with connection 1/2" or 3/4" for installation on external mixer with upper output.

THERMOSTATICO DA BARRA
THERMOSTATIC MIXERTHERMOSTATICO MINIMAL
MINIMAL THERMOSTATIC MIXER

COLONNA CON MISCELATORE THERMOSTATICO:

Colonna completa dotata di soffione, portadoccetta, doccia, flessibile 150 cm, miscelatore termostatico con deviatore integrato.

SHOWER COLUMN WITH THERMOSTATIC MIXER:

Shower column equipped with shower head, hand shower holder, hand shower, flexible hose 150 cm, thermostatic mixer with integrated diverter.

GRUPPO MONOCOMANDO ESTERNO
EXTERNAL MIXERGRUPPO CLASSICO
CLASSIC GROUP

COLONNA CON MISCELATORE:

Colonna completa dotata di soffione, portadoccetta, doccia, flessibile 150 cm, miscelatore e deviatore esterno.

SHOWER COLUMN WITH MIXER:

Shower column equipped with shower head, hand shower holder, hand shower, flexible hose 150 cm, mixer and external diverter.

ESEMPI COMBINAZIONI DOCCIA _ EXAMPLE OF COMBINATIONS



PRESA ACQUA TONDA
ROUND WATER SUPPLY



PRESA ACQUA QUADRA
SQUARE WATER SUPPLY

COLONNA CON PRESA ACQUA:

Colonna dotata di soffione, porta-doccetta, doccia, flessibile 150 cm, presa acqua con deviatore integrato per installazione su uscita dell'acqua a muro e con miscelatore incasso già esistente.

SHOWER COLUMN WITH WATER SUPPLY:

Shower column equipped with shower head, hand shower holder, hand shower, flexible hose 150 cm and water supply with integrated diverter for installation with built-in mixer not included.



PRESA ACQUA SPECIAL TONDA
SPECIAL ROUND WATER SUPPLY



PRESA ACQUA SPECIAL QUADRA
SPECIAL SQUARE WATER SUPPLY

COLONNA con presa acqua SPECIAL:

Colonna dotata di soffione, porta-doccetta, doccia, flessibile 150 cm, supporto a muro con deviatore integrato e collegamento flessibile 40 cm per prelievo dell'acqua dall'uscita a muro o dal gruppo vasca.

SHOWER COLUMN WITH SPECIAL WATER SUPPLY:

Shower column equipped with shower head, hand shower holder, hand shower, flexible hose 150 cm, special water supply with integrated diverter and connection to wall outlet or bath mixer trough flexible hose 40 cm.

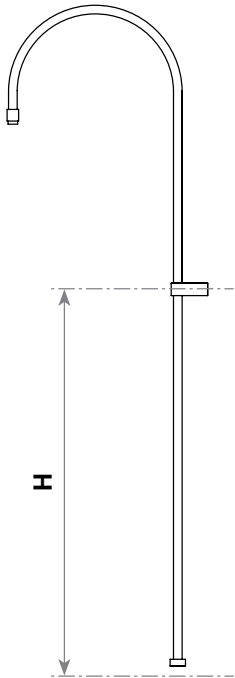

		H
COLONNA COMPLETA SHOWER COLUMN	gruppo moderno modern group	985
	termostatico thermostatic	920
	monocomando mixer	990
	presa acqua water supply	915
COLONNA SENZA RUBINETTO COLUMN WITHOUT TAP		950

Per l'installazione ideale della colonna doccia il soffione deve essere ad un'altezza di circa 2000 mm da terra (intendendo la distanza compresa tra il lato inferiore del soffione ed il piatto doccia). Prima di iniziare il montaggio della colonna doccia vi consigliamo quindi di verificare le quote ed i collegamenti del vostro ambiente bagno, considerando che alcune colonne doccia possono essere personalizzate in altezza.

- 1) Verificare l'altezza massima del vostro ambiente bagno considerando che il prodotto completo, nel suo sviluppo ideale, occupa un'altezza da terra di circa 2250 mm.
- 2) È importante verificare che il sistema di connessione della colonna alla rubinetteria da voi prevista sia corrispondente. Per l'installazione delle colonne Aquaviva il rubinetto (miscelatore, termostatico o tradizionale) deve trovarsi ad un'altezza da terra di circa 1100 mm (per doccia) e di 750 mm (per vasca).

To obtain an ideal shower column installation, the shower head should be positioned at a height of 2000 mm from the floor (i.e. distance between the lower side of the shower head and the shower tray).

Therefore, before installing the shower column, you are advised to check the dimensions and the connections in your bathroom, considering that some models of shower columns can be customized.

1) Check the maximum height of your bathroom, taking into account that the ideal overall product dimensions reach a height of 2250 mm from the floor.

2) It is important to check the connection system of your tap fittings. Top install the Aquaviva column, the shower taps (mixer, thermostatic or traditional) must be at a height of not less than 1100 mm from the floor for the shower cubicle and not less than 750 mm for the bathtub.

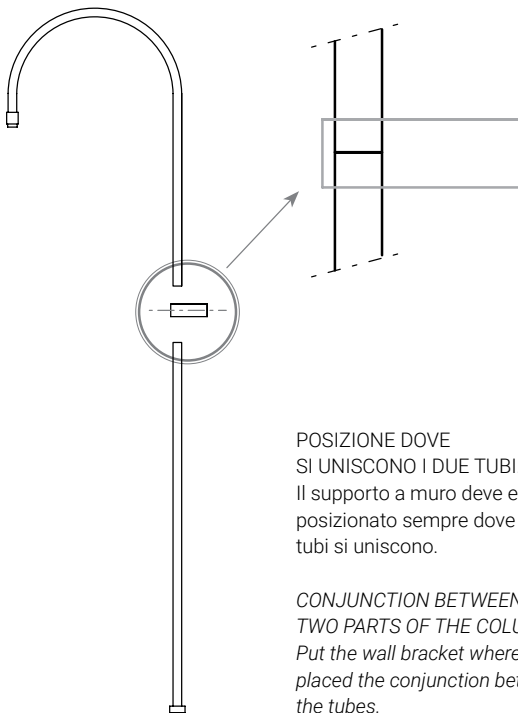

POSIZIONE DOVE SI UNISCONO I DUE TUBI.
Il supporto a muro deve essere posizionato sempre dove i due tubi si uniscono.

CONJUNCTION BETWEEN THE TWO PARTS OF THE COLUMN.
Put the wall bracket where is placed the conjunction between the tubes.

ISTRUZIONI DI MONTAGGIO _ INSTALLATION INSTRUCTIONS

DOCCIA
SHOWER

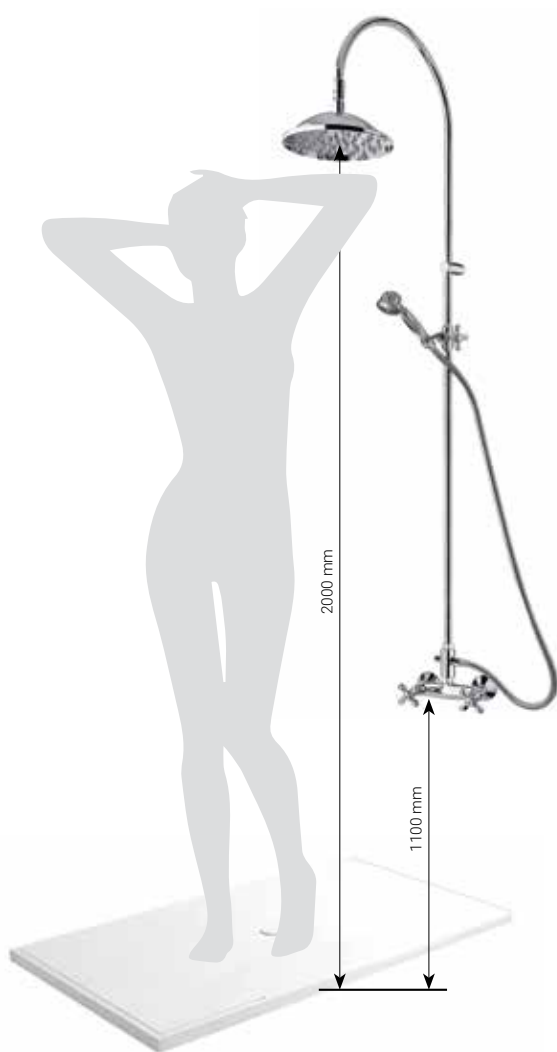

VASCA
BATHTUB



Altezza ottimale di collocazione
in base all'altezza della persona.
Man-height column installation.

H : altezza uomo / man-height

cm 160 170 180 190 200

A : posizione colonna doccia / shower column position

cm 90 100 110 115 120

misura standard

